

Device Features

- AEC-Q100 Grade 2 Qualification Pending
- 7-bit Serial & Parallel Interface
- 31.75dB Control Range 0.25dB step
- Support addressable Function (Addr0-Addr7)
- Glitch-safe attenuation state transitions
- 2.7V to 5.5V supply
- Low Current Consumption 200µA typical
- 1.17V to 3.6V control logic
- Excellent Attenuation Accuracy
 - ±(0.15 + 1.5% of attenuation state) @ 1.9GHz
 - ±(0.25 + 3.5% of attenuation state) @ 3.5GHz
 - ±(0.25 + 7.0% of attenuation state) @ 7.2GHz
- Low Insertion Loss
 - 1.0 dB @ 1.9GHz
 - 1.3 dB @ 3.5GHz
 - 2.8 dB @ 7.2GHz
- Ultra linearity IIP3 > +68dBm @ 3.5GHz, ATT=0dB
- Input 0.1dB Compression (P0.1dB) 30dBm @ 3.5GHz, ATT=0dB
- Programming modes
 - Direct parallel
 - Latched parallel
 - Serial Addressable
- -40°C to +105°C operating temperature
- ESD rating : Class1C (1kV HBM)
- Lead-free/RoHS2-compliant 32-lead 5mm x 5mm x 0.9mm QFN SMT package

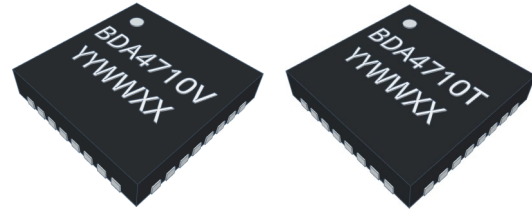

32-lead 5mm x 5 mm x 0.9mm QFN

Figure 1. Package Type

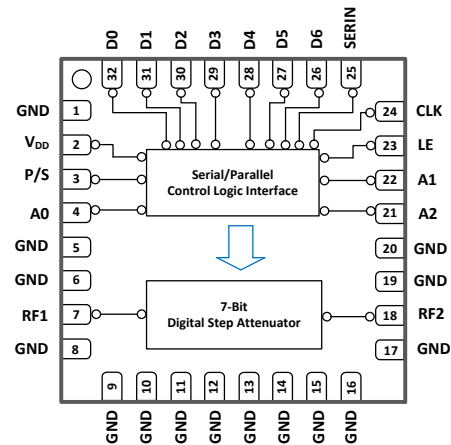

Figure 2. Functional Block Diagram

Product Description

The BDA4710V/BDA4710VT is a broadband, Highly accurate 50Ω digital step attenuator model which provides adjustable attenuation from 0 to 31.75 dB in 0.25 dB steps. The control interface supports a 7-bit serial interface with 3-bit addressable function and latched parallel interface.

BDA4710V/BDA4710VT supports a broad operating frequency range from 1MHz to 9.0 GHz. BDA4710V/BDA4710VT is offering the High linearity, low power consumption, high attenuation accuracy and low insertion loss, typically less than 3.0dB up to 8.5GHz.

The device features a safe state transitions with no negative/positive Glitch technology optimized for excellent step accuracy.

Basically the RF input and output are internally matched to 50 Ω and do not require any external matching components. In some cases to optimize Return loss for above 4 - 8.5GHz, Shunt capacitor can be added near RF1 and RF2 respectively. The design is bi-directional; Therefore, the RF input and output are interchangeable.

The BDA4710V/BDA4710VT does not require blocking capacitors. If DC is presented at the RF port, add a blocking capacitor. This is packaged in a RoHS2-compliant with QFN surface mount package.

The BDA4710V/BDA4710VT is undergoing AEC-Q100 Grade 2 qualification.

Application

- Automotive
- Vehicle to Everything(V2X)
- Telematics / Infotainment / ADAS
- WLAN 802.11 a/n/ac/ax
- Bluetooth
- Remote Keyless Entry
- GPS/Navigation
- Wireless control systems

Ordering Information

Part Number	Descriptions
BDA4710V	Mass Test in RT(+25°C)
BDA4710VT	Mass Test in LT(-40°C) / RT(+25°C) / HT(+105°C)
BDA4710V-EVB BDA4710VT-EVB	BDA4710V/BDA4710VT Evaluation Board
BDA4710V-EVK BDA4710VT-EVK	BDA4710V/BDA4710VT Evaluation Board Kit (Evaluation Board + Control Board)

Table 1. Electrical Specifications

Specifications are performance on the BeRex EVKit at VDD=3.3V, 25°C, 50Ω system. Performance were measured based on Typical application circuits Table 13. (See the Page 9)

Parameter	Condition	Frequency	Min	Typ	Max	Unit	
Frequency Range			1		8000	MHz	
Attenuation range	0.25dB step			0 - 31.75		dB	
Insertion Loss ¹	ATT = 0dB	1MHz - 1GHz		0.8		dB	
		1 - 2GHz		1.0		dB	
		2 - 4GHz		1.5		dB	
		4 - 6GHz		2.6		dB	
		6 - 8GHz		2.9		dB	
Attenuation Error	0.25dB Step	1MHz - 2GHz			±(0.15 + 1.5% of attenuation state)	dB	
		2 - 3GHz			±(0.15 + 2.5% of attenuation state)		
		3 - 5GHz			±(0.25 + 3.5% of attenuation state)		
		5 - 6GHz			±(0.25 + 5.0% of attenuation state)		
	1dB Step	0-31.0dB	1MHz - 2GHz			±(0.15 + 1.5% of attenuation state)	dB
			2 - 3GHz			±(0.15 + 2.5% of attenuation state)	
			3 - 5GHz			±(0.25 + 3.5% of attenuation state)	
			5 - 6GHz			±(0.25 + 5.0% of attenuation state)	
			6 - 8GHz			±(0.25 + 7.0% of attenuation state)	
Input Return Loss	ATT = 0dB	1 - 4GHz		20		dB	
		4 - 8GHz		10			
Output Return Loss	ATT = 0dB	1 - 4GHz		20		dB	
		4 - 8GHz		10			
Relative Phase Error	All States	1GHz		6		degree	
		2GHz		12			
		3GHz		19			
		4GHz		27			
		5GHz		35			
		6GHz		43			
Input Linearity	Input 0.1dB Compression point	ATT = 0dB	3.5GHz		30	dBm	
	Input IP3	Pin = +18dBm/tone, Δf = 20MHz ATT = 0.0dB RF Input = RF1 Port	2.5GHz		63	dBm	
			3.5GHz		68		
			4.5GHz		59		
			7.25GHz		52		
		Pin = +18dBm/tone, Δf = 20MHz ATT = 31.75dB RF Input = RF1 Port	2.5GHz		59		
			3.5GHz		58		
			4.5GHz		54		
			7.25GHz		51		
		Pin = +18dBm/tone, Δf = 20MHz ATT = 0.0dB RF Input = RF2 Port	2.5GHz		64		
			3.5GHz		60		
			4.5GHz		58		
			7.25GHz		49		
		Pin = +18dBm/tone, Δf = 20MHz ATT = 31.75dB RF Input = RF2 Port	2.5GHz		58		
			3.5GHz		57		
			4.5GHz		56		
7.25GHz			42				

Preliminary Datasheet

Table 1. Electrical Specifications (Cont.)

Parameter	Condition	Frequency	Min	Typ	Max	Unit
RF Rising / Falling Time	10%/90% RF	2GHz		121		ns
Switching time	50% CTRL to 90% or 10% RF	2GHz		224		ns
Settling time	50% CTRL to Max or Min Attenuation to settle within 0.05 dB of final value	2GHz		500		ns
Attenuation Transient (envelope) ²	Positive glitch, Any ATT step	3.5GHz		0.3		dB
Maximum Spurious level	Measured at RF1 and RF2 port	1 - 5MHz		-142		dBm/10Hz
		>5MHz ³		< -145		

1. The Evaluation board Kit insertion loss (PCB & RF Connector) is de-embedded.

2. Attenuation Transient is glitch level due to attenuation transitions

3. No spurious signals were detected above 5MHz.

Table 2. Electrical Specifications¹ (Optimized Return Loss Application)

Specifications are performance on the BeRex EVKit at VDD=3.3V, 25°C, 50 Ω system. Performance were measured based on Optimized Return Loss Application Circuits Table 14. (See the Page 16)

Parameter	Condition	Frequency	Min	Typ	Max	Unit
Frequency Range			1		9000	MHz
Attenuation range	0.25dB step			0 - 31.75		dB
Insertion Loss ²	ATT = 0dB	1MHz - 1GHz		0.7		dB
		1 - 2GHz		1.0		dB
		2 - 3GHz		1.1		dB
		3 - 4GHz		1.3		dB
		4 - 6GHz		1.8		dB
		6 - 8GHz		2.6		dB
		8 - 9GHz		3.8		dB
Attenuation Error	0-31.75dB / 0.25dB Step	1MHz - 2GHz			±(0.15 + 1.5% of attenuation state)	dB
		2 - 3GHz			±(0.15 + 2.5% of attenuation state)	dB
		3 - 4GHz			±(0.25 + 3.5% of attenuation state)	dB
		4 - 6GHz			±(0.25 + 5.0% of attenuation state)	dB
		6 - 9GHz			±(0.35 + 7.0% of attenuation state)	dB
Input Return Loss	ATT = 0dB	1 - 4GHz		18		dB
		4 - 6GHz		15		
		6 - 9GHz		20		
Output Return Loss	ATT = 0dB	1 - 4GHz		19		dB
		4 - 6GHz		16		
		6 - 9GHz		17		
Relative Phase Error	All states	1GHz		6		degree
		2GHz		11		
		3GHz		18		
		4GHz		26		
		5GHz		34		
		6GHz		43		
		7GHz		52		
		8GHz		65		
9GHz		76				

1. In order to improve Return loss above 4GHz, shunt capacitor 0.1pF was added to each RF1 & RF2. (See Optimized Return loss application circuits Table 14 on page 16)

2. The Evaluation board Kit insertion loss (PCB & RF Connector) is de-embedded.

Table 3. Recommended Operating Condition

Parameter	Symbol	Condition	Min	Typ	Max	Unit
Supply Voltages	V_{DD}		2.7		5.5	V
Supply Current	I_{DD}			200	350	μ A
Digital Control Input	High	V_{CTLH}	$V_{DD}=3.3V$ or $5V$	1.17	3.6	V
	Low	V_{CTLL}	$V_{DD}=3.3V$ or $5V$	-0.3	0.6	V
Operating Temperature Range	T_{case}	Exposed Paddle	-40		105	$^{\circ}$ C
RF Max Input Power	P_{IN_CW}	RF1 or RF2, CW (> 50MHz)			24	dBm
Impedance	Z_{Load}	Single ended		50		Ω

Specifications are not guaranteed over all recommended operating conditions.

Table 4. Absolute Maximum Ratings

Parameter	Symbol	Min	Typ	Max	Unit
Supply Voltage	V_{DD}	-0.3		5.5	V
Digital Input Voltage	V_{CTL}	-0.3		3.6	V
Maximum Input Power	P_{IN_CWMAX}			31	dBm
Temperature	Storage	T_{ST}	-65	150	$^{\circ}$ C
	Reflow	T_R		260	$^{\circ}$ C
ESD Sensitivity	HBM ¹	ESD_{HBM}		± 1000 (Class 1C)	V
	CDM ²	ESD_{CDM}		± 1000 (Class C3)	V

Operation of this device above any of these parameters may result in permanent damage.

1. HBM : Human Body Model (JEDEC Standard JS-001-2017)
2. CDM : Charged Device Model (JEDEC Standard JS-002-2018)

Table 5. Package Thermal Characteristics

Parameter	Symbol	Value	Unit
Junction to Ambient Thermal Resistance	θ_{JA}	30.1	$^{\circ}$ C/W

Figure 3. Pin Configuration (Top View)

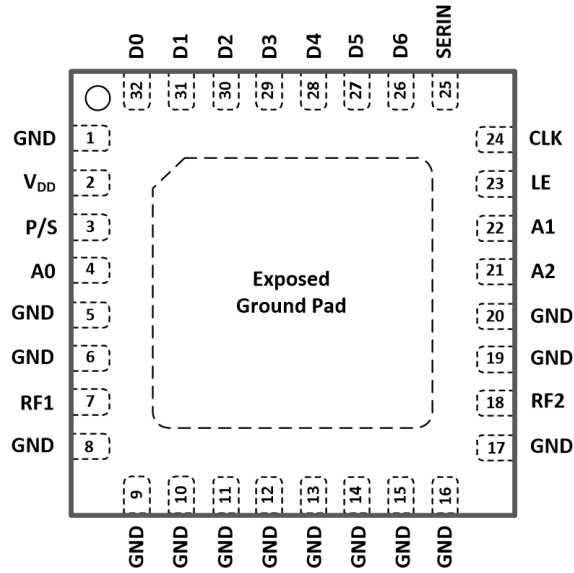

Table 6. Pin Description

Pin	Pin name	Description
1, 5, 6, 8-17, 19, 20	GND	Ground, These pins must be connected to ground
2	VDD	Power Supply (nominal 3.3V)
3	P/S	Parallel/Serial Mode Select. For parallel mode operation, set this pin to LOW. For serial mode operation, set this pin to HIGH.
4	A0	Address bit A0 connection.
7	RF1 ¹	RF1 port (Attenuator RF Input) This pin can also be used as an output because the design is bidirectional. RF1 is dc-coupled and matched to 50 Ω
18	RF2 ¹	RF2 port (Attenuator RF Output.) This pin can also be used as an input because the design is bidirectional. RF2 is dc-coupled and matched to 50 Ω.
21	A2	Address bit A2 connection.
22	A1	Address bit A1 connection.
23	LE	Latch Enable input
24	CLK	Serial interface clock input
25	SERIN	Serial interface data input
26	D6 ²	Parallel Control Voltage Inputs, Attenuation control bit 16dB
27	D5 ²	Parallel Control Voltage Inputs, Attenuation control bit 8dB
28	D4 ²	Parallel Control Voltage Inputs, Attenuation control bit 4dB
29	D3 ²	Parallel Control Voltage Inputs, Attenuation control bit 2dB
30	D2 ²	Parallel Control Voltage Inputs, Attenuation control bit 1dB
31	D1 ²	Parallel Control Voltage Inputs, Attenuation control bit 0.5dB
32	D0 ²	Parallel Control Voltage Inputs, Attenuation control bit 0.25dB
Pad	GND	Exposed pad: The exposed pad must be connected to ground for proper operation

1. RF pins 7 and 18 must be at 0V DC. The RF pins do not require DC blocking capacitors for proper Operation if the 0V DC requirement is met.
2. It is recommended to ground the D0 ~ D6 in serial mode.

Programming Options

BDA4710V/BDA4710VT can be programmed using either the parallel or serial interface, which is selectable via P/S pin(Pin3). Serial mode is selected by pulling it to a voltage logic HIGH and parallel mode is selected by setting P/S to logic LOW

Serial Control Mode

The serial interface is a 16-bit shift register to shift in the data LSB (D0) first. When serial programming is used, It is recommended all the parallel control input pins (26, 27, 28, 29, 30, 31, 32) are grounded. It is controlled by three CMOS-compatible signals: SERIN, Clock, and Latch Enable (LE).

Table 7. Truth Table for Serial Control Word

Digital Control Input								Attenuation state (dB)
D7 (MSB)	D6	D5	D4	D3	D2	D1	D0 (LSB)	
LOW	LOW	LOW	LOW	LOW	LOW	LOW	LOW	0 (RL)
LOW	LOW	LOW	LOW	LOW	LOW	LOW	HIGH	0.25
LOW	LOW	LOW	LOW	LOW	LOW	HIGH	LOW	0.5
LOW	LOW	LOW	LOW	LOW	HIGH	LOW	LOW	1.0
LOW	LOW	LOW	LOW	HIGH	LOW	LOW	LOW	2.0
LOW	LOW	LOW	HIGH	LOW	LOW	LOW	LOW	4.0
LOW	LOW	HIGH	LOW	LOW	LOW	LOW	LOW	8.0
LOW	HIGH	LOW	LOW	LOW	LOW	LOW	LOW	16.0
LOW	HIGH	HIGH	HIGH	HIGH	HIGH	HIGH	HIGH	31.75

Figure 4. Serial Mode Timing Diagram

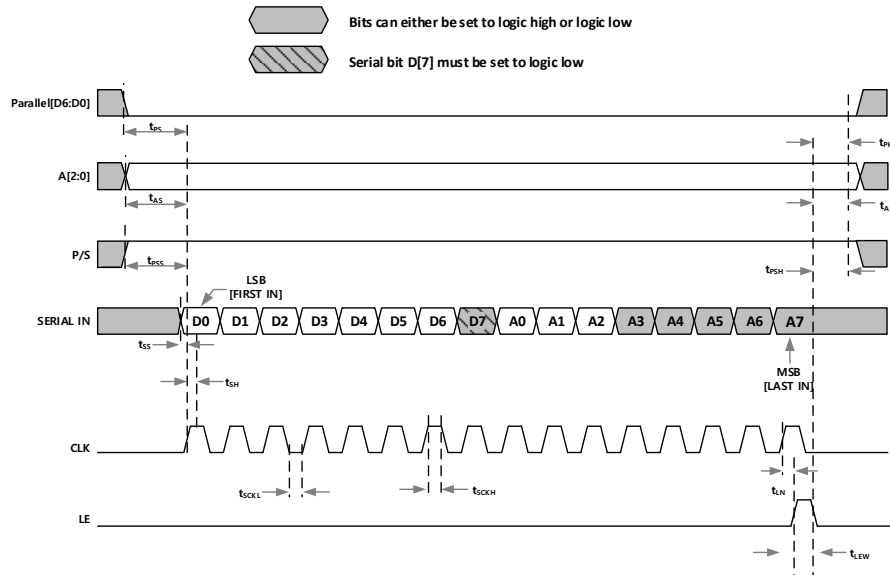

BDA4710V/BDA4710VT Serial mode is selected by pulling it to logic HIGH. The serial interface is a 16-bit shift register made up of two words. The first 8-bit word is the Attenuation word, which controls the DSA state. The second word is the address word, which uses only 3 of 8-bits that must match the hard wired A0-A2 programming in order to change the DSA state. If no external connections are made to A0 – A2 then internally they will default to 000 due to internal pull down resistors. If these 3 external preset address bits are not matched with the SPI loaded address bits then the current attenuator state will remain unchanged. This allows up to 8 serial-controlled devices to be used on a single board, which share a common SERIN, CLK and LE.

When serial programming is used, all the parallel control input pins 26 – 32 can be left open or grounded.

Table 8. Serial Interface Timing Specifications

Symbol	Parameter	Min	Typ	Max	Unit
f _{CLK}	Serial data clock frequency			10	MHz
t _{PS}	Parallel data setup time	100			ns
t _{PH}	Parallel data hold time	100			ns
t _{AS}	Address setup time	100			ns
t _{AH}	Address hold time	100			ns
t _{PSS}	Parallel/Serail setup time	100			ns
t _{PSH}	Parallel/Serail hold time	100			ns
t _{SS}	Serial Data setup time	10			ns
t _{SH}	Serial Data hold time	10			ns
t _{SCKH}	Serial clock high time	30			ns
t _{SCKL}	Serial clock low time	30			ns
t _{LN}	LE setup time	10			ns
t _{LEW}	Minimum LE pulse width	30			ns

Serial Register Map

The BDA4710V/BDA4710VT can be programmed via the serial control on the rising edge of Latch Enable (LE) which loads the last 8-bits attenuation word and 8-bits address word in the SHIFT Register. Data is clocked in LSB(D0) first. The shift register must be loaded while LE is kept LOW to prevent changing the attenuation value during data is inputted.

Figure 5. Serial Register Map

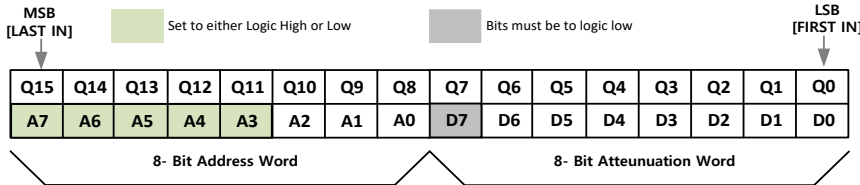

The serial register consist of 16 bits as shown in Figure 5. First 8 bits from LSB are Attenuation word, 8 bits after that are Address word. The Attenuation word is DSA attenuation control bit and the Address word is static logical bit determined by A0, A1 and A2 digital inputs. The attenuation word is derived directly from the value of the attenuation state. To find the attenuation word, multiply the value of the state by four because of 0.25dB step up to 31.75dB (total 127 Attenuation state), then convert to binary.

For example, to program attenuation 15.75dB state of Addr[5] BDA4710V/BDA4710VT :

Attenuation State	Address state
4 x 15.75 = 63	Digital input of A2, A1, A0 pin = 101
63 -> 00111111	A7 - A0 : xxxxx101

Serial Input : xxxxx10100111111

x	x	x	x	x	1	0	1	0	0	1	1	1	1	1	1
A7	A6	A5	A4	A3	A2	A1	A0	D7	D6	D5	D4	D3	D2	D1	D0

Table 9. Truth Table for Address Control Word

Address Digital Control Input								Address Setting	Addr No.
A7 (MSB)	A6	A5	A4	A3	A2	A1	A0 (LSB)		
X	X	X	X	X	LOW	LOW	LOW	000	Addr[0]
X	X	X	X	X	LOW	LOW	HIGH	001	Addr[1]
X	X	X	X	X	LOW	HIGH	LOW	010	Addr[2]
X	X	X	X	X	LOW	HIGH	HIGH	011	Addr[3]
X	X	X	X	X	HIGH	LOW	LOW	100	Addr[4]
X	X	X	X	X	HIGH	LOW	HIGH	101	Addr[5]
X	X	X	X	X	HIGH	HIGH	LOW	110	Addr[6]
X	X	X	X	X	HIGH	HIGH	HIGH	111	Addr[7]

Table 10. Mode Selection

P/S	Control Mode
LOW	Parallel
HIGH	Serial Addressable

Power-UP states Settings

The BDA4710V/BDA4710VT will always initialize to the maximum attenuation setting (31.75 dB) on power-up for both the Serial and Latched Parallel modes of operation and will remain in this setting until the user latches in the next programming word. In Direct Parallel mode, the DSA can be preset to any state within the 31.75 dB range by pre-setting the Parallel control pins prior to power-up. In this mode, there is a 400 μs delay between the time the DSA is powered-up to the time the desired state is set.

Figure 6. Default Attenuation Word for Power-up state

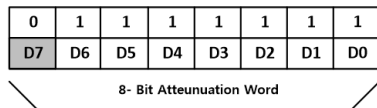

Programming Options

Parallel Control Mode

The parallel control interface has seven digital control input lines (D6 to D0) to set the attenuation value. D6 is the most significant bit (MSB) that selects the 16 dB attenuator stage, and D0 is the least significant bit (LSB) that selects the 0.25 dB attenuator stage (see Figure 7).

Direct Parallel Mode

For direct parallel mode, The LE pin must be kept HIGH. The attenuation state is changed by the control voltage inputs (D0 to D6) directly. This mode is ideal for manual control of the attenuator. In this mode the device will immediately react to any voltage changes to the parallel control pins [pins 26, 27, 28, 29, 30, 31, 32]. Use direct parallel mode for the fastest settling time.

Latched Parallel Mode

The LE pin must be kept LOW when changing the control voltage inputs (D0 to D6) to set the attenuation state. When the desired state is set, LE must be toggled HIGH to transfer the 7-bit data to the bypass switches of the attenuator array, and then toggled LOW to latch the change into the device until the next desired attenuation change (see Figure 7 and Table 11).

- Set P/S is logic LOW.
- Set LE to logic LOW.
- Adjust pins [26, 27, 28, 29, 30, 31, 32] to the desired attenuation setting. (Note the device will not react to these pins while LE is a logic LOW).
- Pull LE to a logic HIGH. The device will then transition to the attenuation settings reflected by pins D6 - D0.
- If LE is pulled to a logic LOW then the attenuator will not change state.

Latched Parallel Mode implies a default state for when the device is first powered up with P/S pin set for logic LOW and LE logic LOW. In this case the default setting is **Maximum attenuation**.

Switching Feature Description

Glitch-Safe Attenuation State Transient

The BDA4710V/BDA4710VT is the latest product applied *Glitch-Safe* technology with less than 1dB ringing (pos/neg) across the attenuation range when changing attenuation states. This technology protects Amplifiers or ADC during transitions between attenuation states. (see Figure 40,41).

Table 11. Truth Table for the Parallel Control Word

D6	D5	D4	D3	D2	D1	D0	P/S	LE	Attenuation State(dB)
LOW	LOW	LOW	LOW	LOW	LOW	LOW	LOW	HIGH	0 (RL)
LOW	LOW	LOW	LOW	LOW	LOW	HIGH	LOW	HIGH	0.25
LOW	LOW	LOW	LOW	LOW	HIGH	LOW	LOW	HIGH	0.5
LOW	LOW	LOW	LOW	HIGH	LOW	LOW	LOW	HIGH	1.0
LOW	LOW	LOW	HIGH	LOW	LOW	LOW	LOW	HIGH	2.0
LOW	LOW	HIGH	LOW	LOW	LOW	LOW	LOW	HIGH	4.0
LOW	HIGH	LOW	LOW	LOW	LOW	LOW	LOW	HIGH	8.0
HIGH	LOW	LOW	LOW	LOW	LOW	LOW	LOW	HIGH	16.0
HIGH	HIGH	HIGH	HIGH	HIGH	HIGH	HIGH	LOW	HIGH	31.75

Figure 7. Latched Parallel Mode Timing Diagram

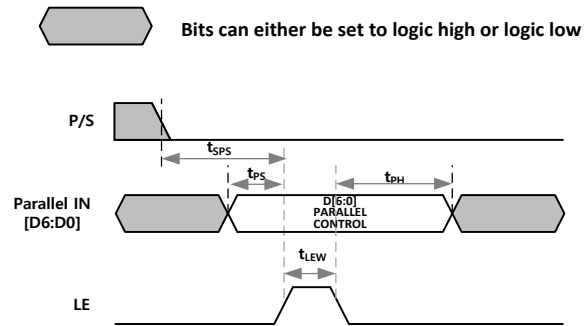

Table 12. Parallel Interface Timing Specifications

Symbol	Parameter	Min	Typ	Max	Unit
t_{SPS}	Serial to Parallel Mode Setup Time	100			ns
t_{LEW}	Minimum LE pulse width	10			ns
t_{PH}	Data hold time from LE	10			ns
t_{PS}	Data setup time to LE	10			ns

Typical RF Performance Plot - BDA4710V/BDA4710VT EVK - PCB (Typical Application Circuits)

Typical Performance Data @ 25°C and $V_{DD} = 3.3V$, EVKit RF connector and board losses are de-embedded, unless otherwise noted

Table 13. Typical Application Circuits

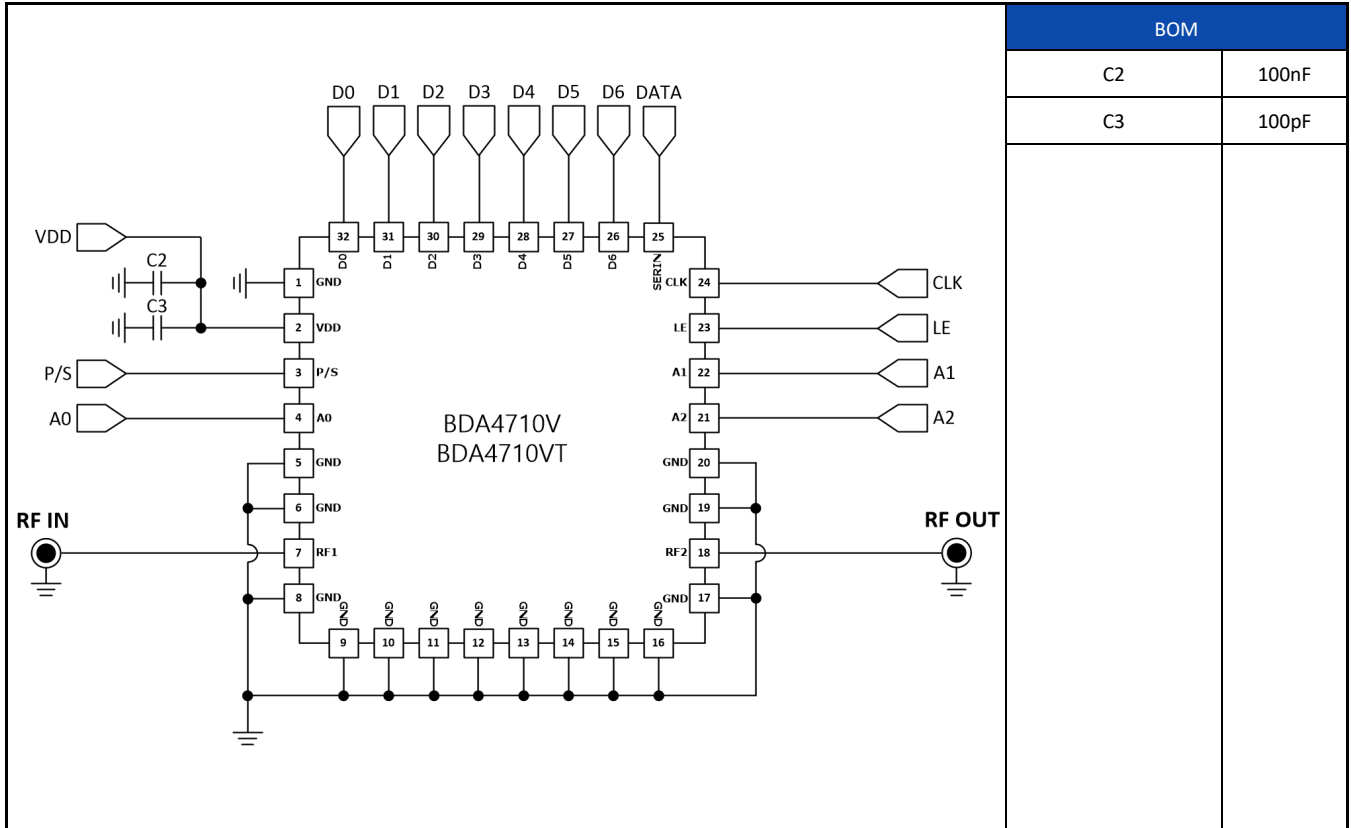

1. See the page 21 the Evaluation Board Circuits for the detailed application circuit information.

Figure 8. Insertion Loss vs Temp.

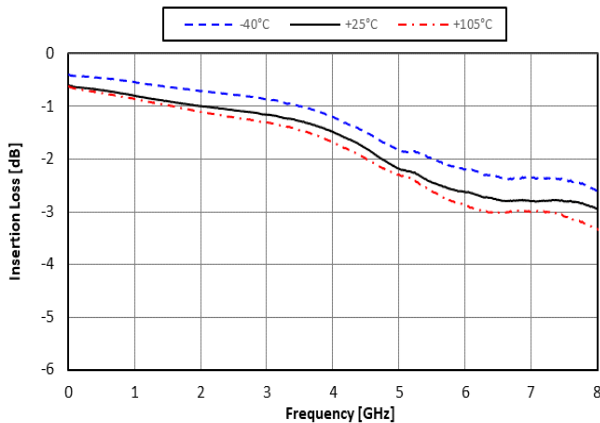
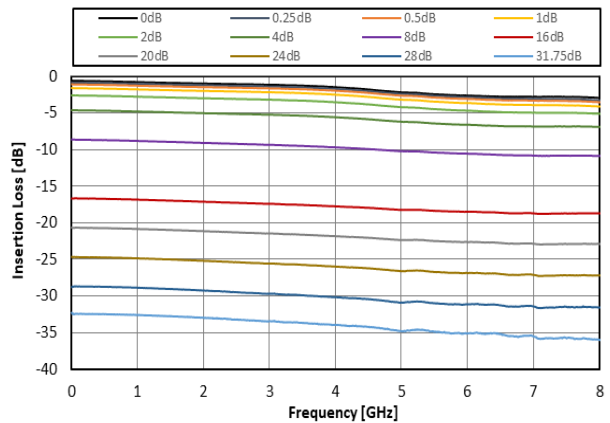

Figure 9. Insertion Loss vs ATT Setting



Preliminary Datasheet

Typical RF Performance Plot - BDA4710V/BDA4710VT EVK - PCB (Typical Application Circuits)

Typical Performance Data @ 25°C and $V_{DD} = 3.3V$, EVKit RF connector and board losses are de-embedded, unless otherwise noted

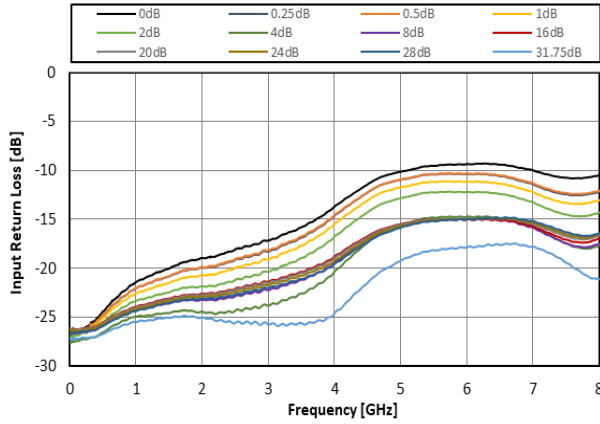
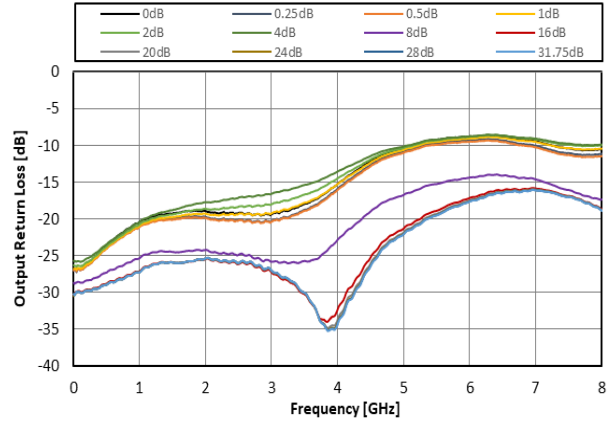
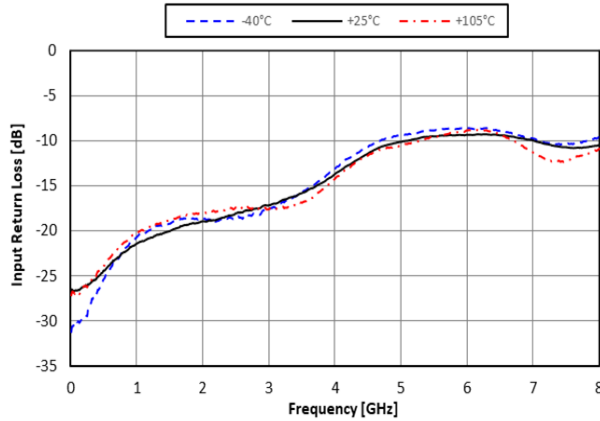
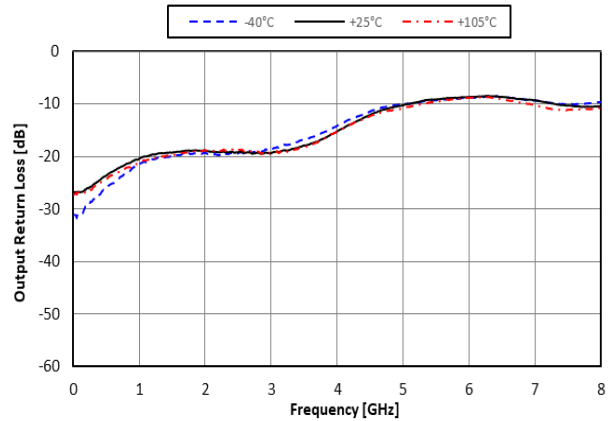
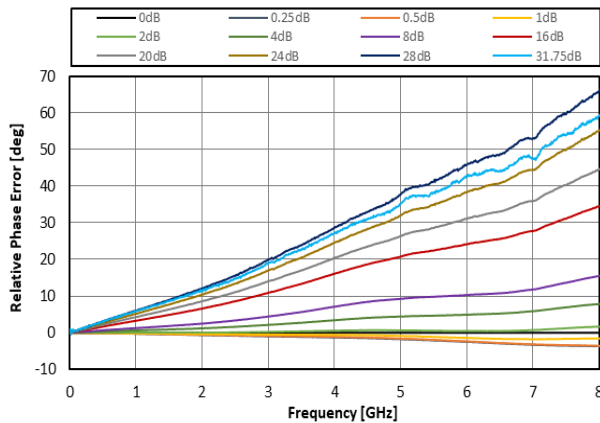
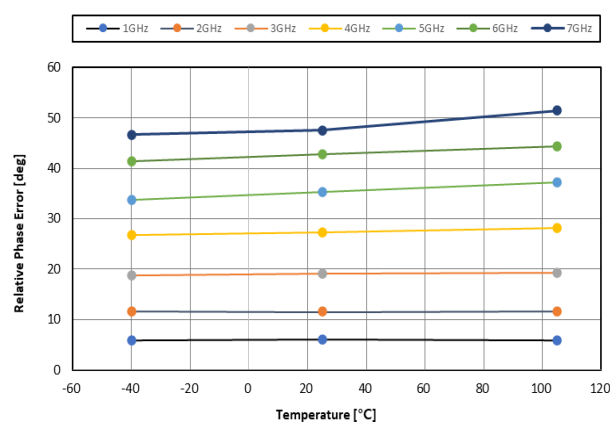
Figure 10. Input Return Loss vs ATT Setting

Figure 11. Output Return Loss vs ATT Setting

Figure 12. Input Return Loss vs Temp. @ ATT = 0dB

Figure 13. Output Return Loss vs Temp. @ ATT = 0dB

Figure 14. Relative Phase Error vs ATT Setting

Figure 15. Relative Phase Error vs Frequency @ ATT = 31.5dB

Preliminary Datasheet

Typical RF Performance Plot - BDA4710V/BDA4710VT EVK - PCB (Typical Application Circuits)

Typical Performance Data @ 25°C and $V_{DD} = 3.3V$, EVKit RF connector and board losses are de-embedded, unless otherwise noted

Figure 16. ATT Error vs Temp. @ 900MHz

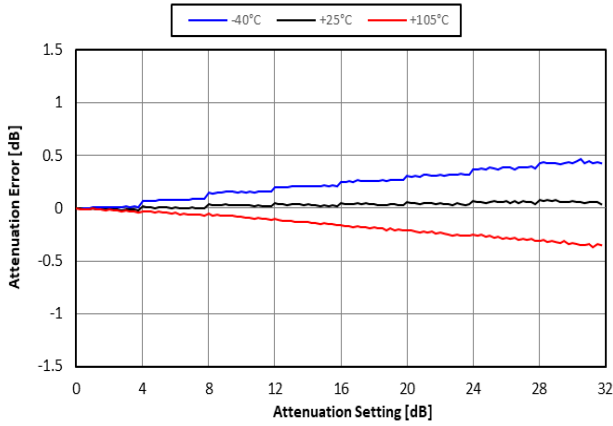

Figure 17. ATT Error vs Temp. @ 1800MHz

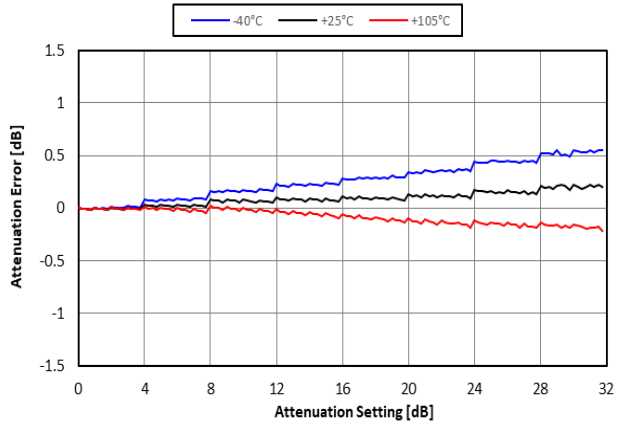

Figure 18. ATT Error vs Temp. @ 2200MHz

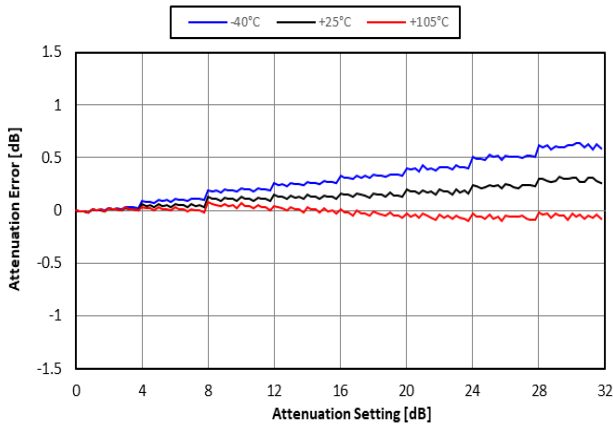

Figure 19. ATT Error vs Temp. @ 3500MHz

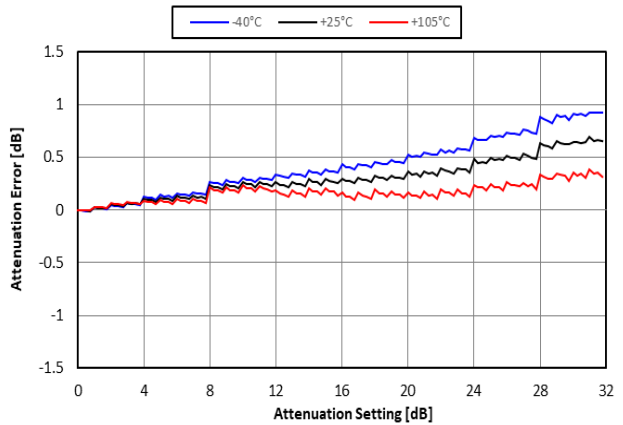

Figure 20. ATT Error vs Temp. @ 4600MHz

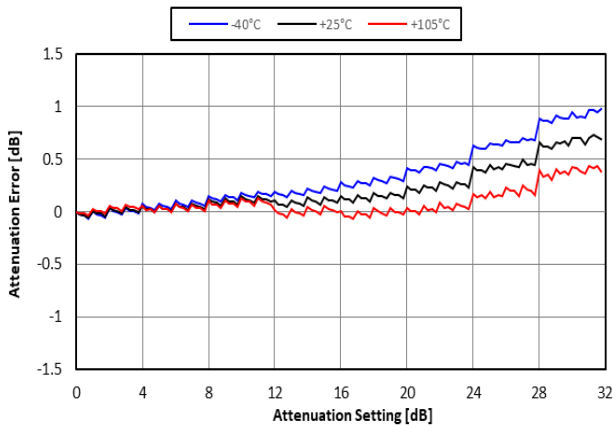
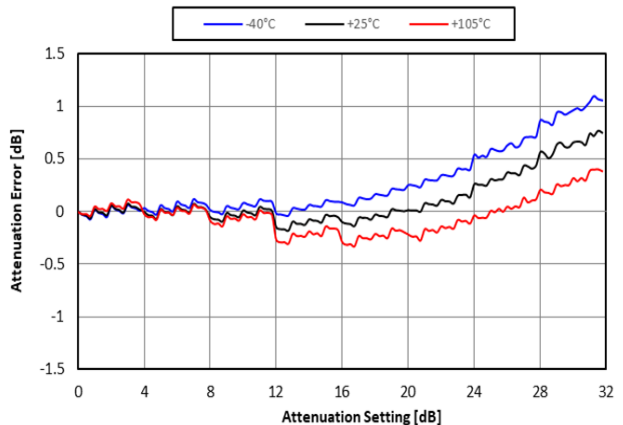

Figure 21. ATT Error vs Temp. @ 5800MHz



Preliminary Datasheet

Typical RF Performance Plot - BDA4710V/BDA4710VT EVK - PCB (Typical Application Circuits)

Typical Performance Data @ 25°C and $V_{DD} = 3.3V$, EVKit RF connector and board losses are de-embedded, unless otherwise noted

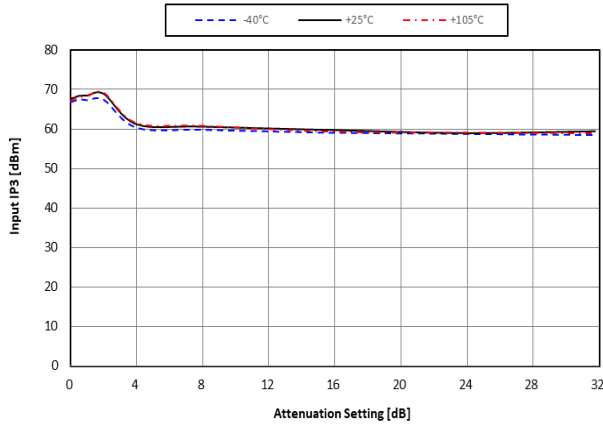
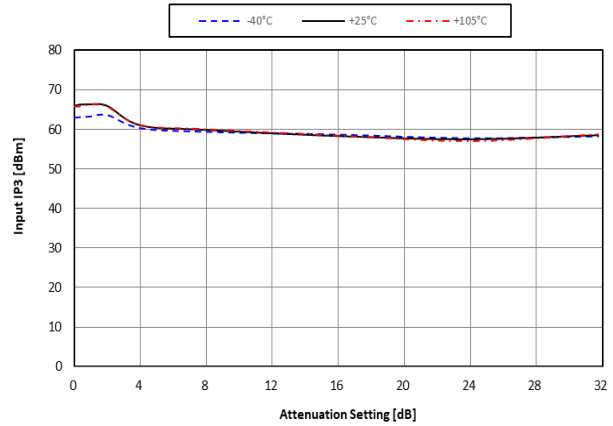
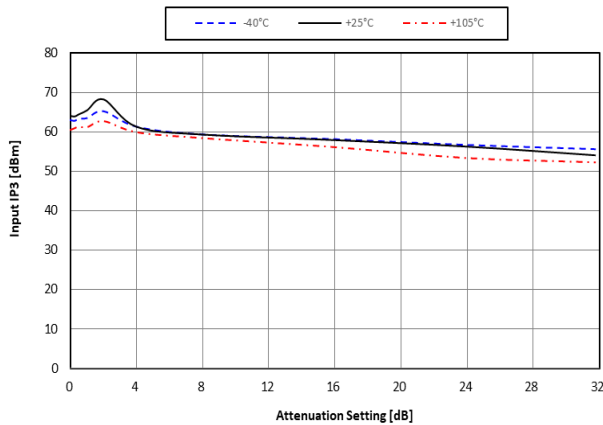
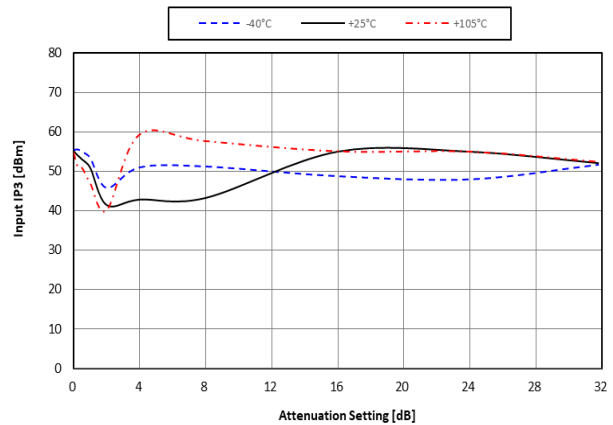
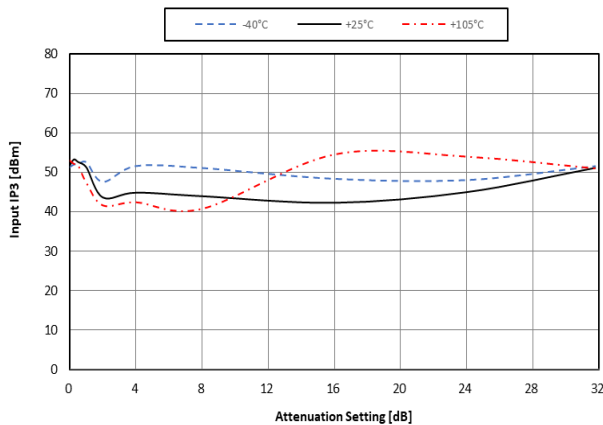
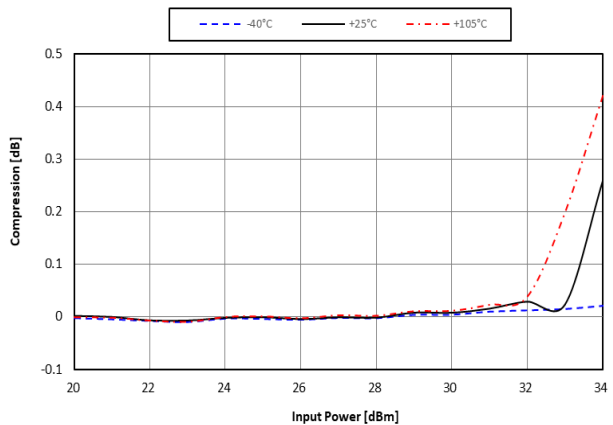
Figure 22. IIP3 vs Temp. @ 2500MHz

Figure 23. IIP3 vs Temp. @ 3500MHz

Figure 24. IIP3 vs Temp. @ 4500MHz

Figure 25. IIP3 vs Temp. @ 6400MHz

Figure 26. IIP3 vs Temp. @ 7250MHz

Figure 27. Input 0.1dB Compression vs Temp. @ 2500MHz

Preliminary Datasheet

Typical RF Performance Plot - BDA4710V/BDA4710VT EVK - PCB (Typical Application Circuits)

Typical Performance Data @ 25°C and $V_{DD} = 3.3V$, EVKit RF connector and board losses are de-embedded, unless otherwise noted

Figure 28. Input 0.1dB Compression vs Temp. @ 3500MHz

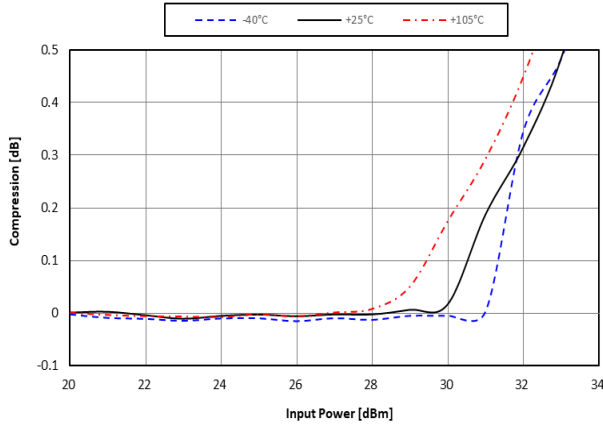

Figure 29. Input 0.1dB Compression vs Temp. @ 4500MHz

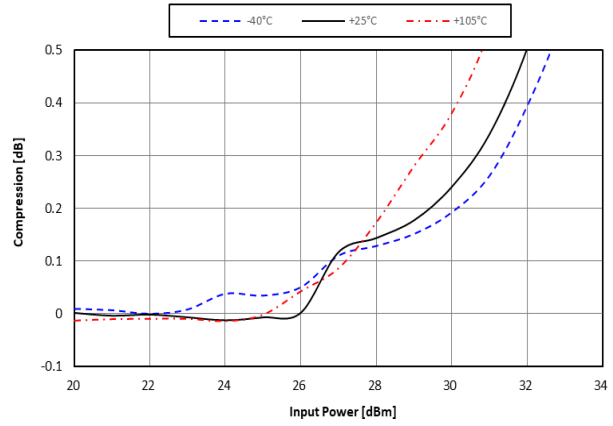

Figure 30. Input 0.1dB Compression vs Temp. @ 5500MHz

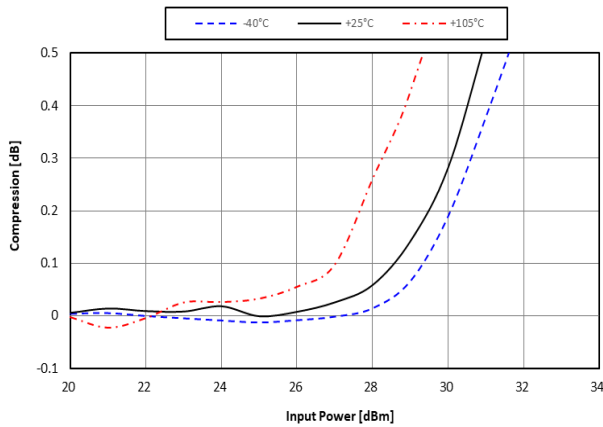

Figure 31. Input 0.1dB Compression vs Temp. @ 7250MHz

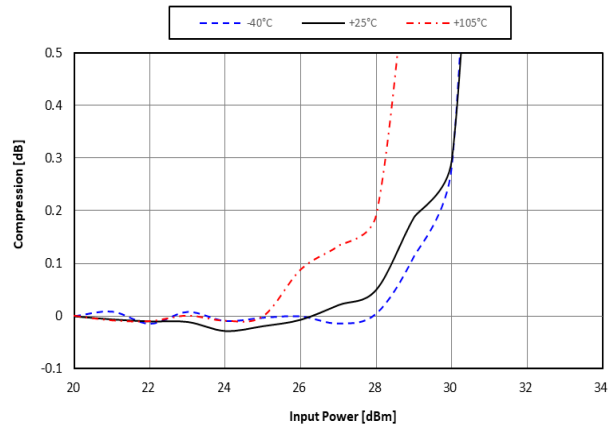

Figure 32. 0.25dB Step ATT vs Frequency

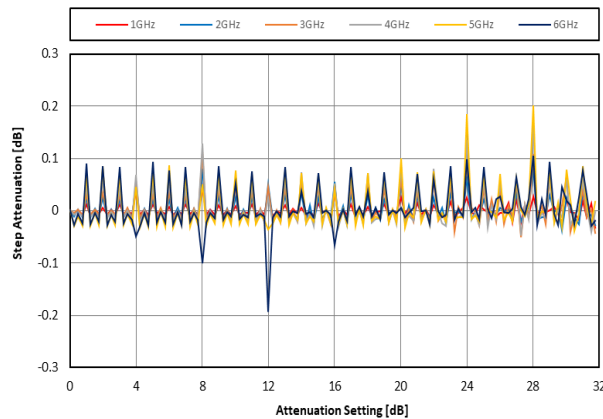
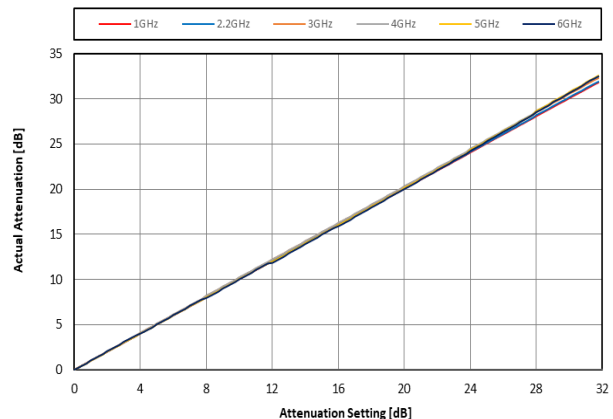

Figure 33. 0.25dB Step Actual ATT vs Frequency



Preliminary Datasheet

Typical RF Performance Plot - BDA4710V/BDA4710VT EVK - PCB (Typical Application Circuits)

Typical Performance Data @ 25°C and $V_{DD} = 3.3V$, EVKit RF connector and board losses are de-embedded, unless otherwise noted

Figure 34. 0.25dB Major State Bit Error vs ATT Setting

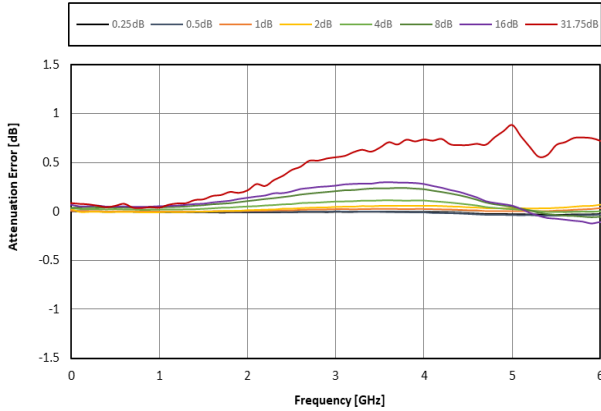

Figure 35. 0.25dB Step ATT Error vs Frequency

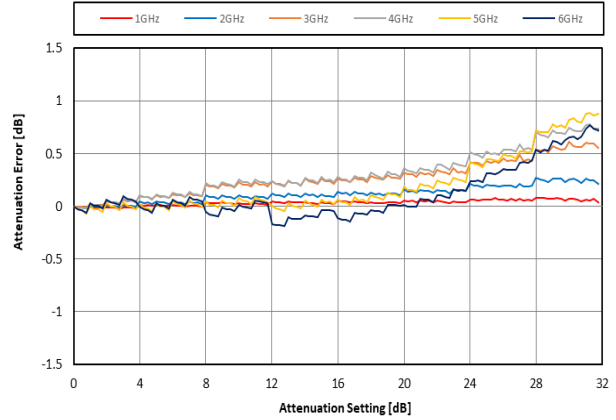

Figure 36. 1dB Step ATT vs Frequency

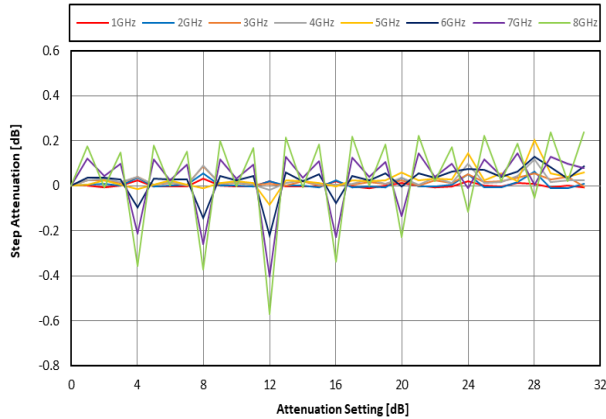

Figure 37. 1dB Step Actual ATT vs Frequency

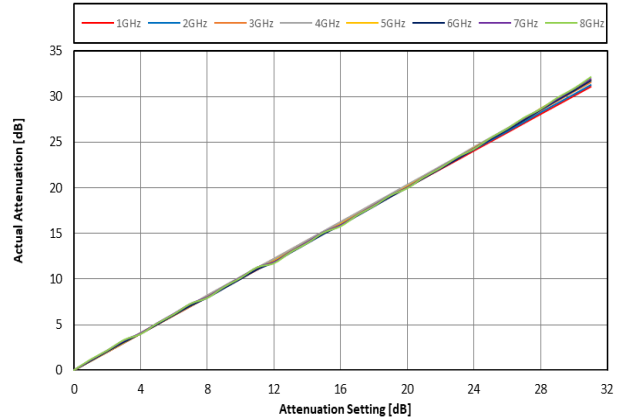

Figure 38. 1dB Major State Bit Error vs ATT Setting

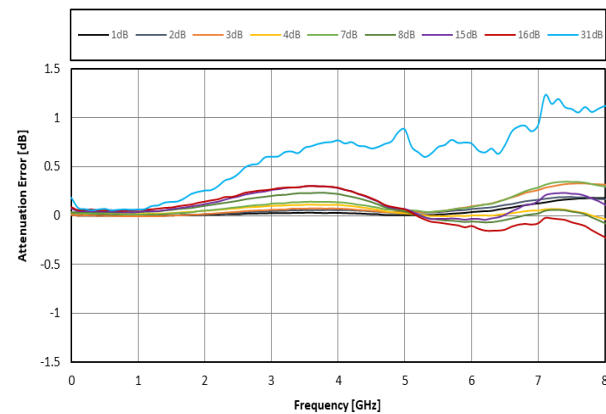
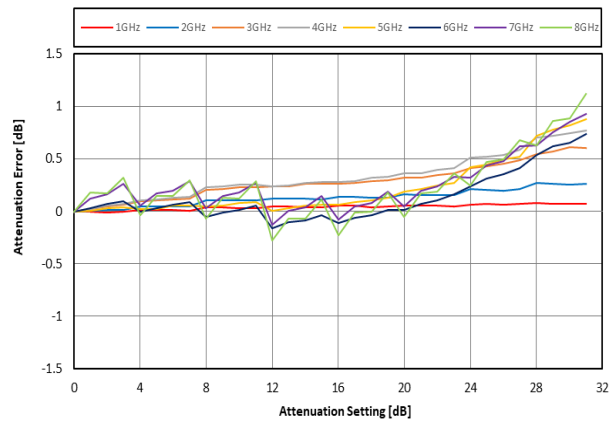

Figure 39. 1dB Step ATT Error vs Frequency



Preliminary Datasheet

Typical RF Performance Plot - BDA4710V/BDA4710VT EVK - PCB (Typical Application Circuits)

Typical Performance Data @ 25°C and $V_{DD} = 3.3V$, EVKit RF connector and board losses are de-embedded, unless otherwise noted

Figure 40. ATT Transient (15.75 to 16dB, Pin=18dBm)

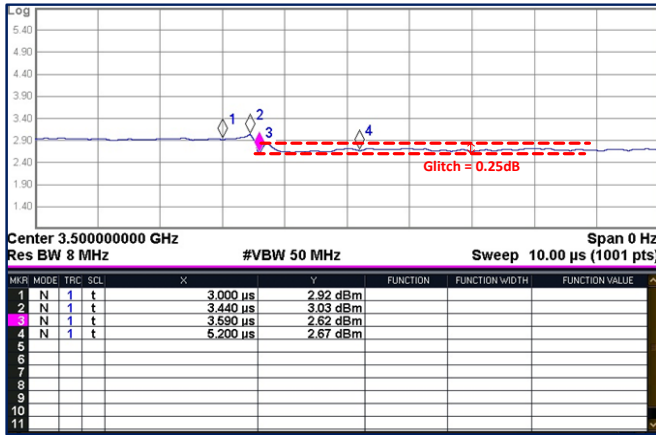
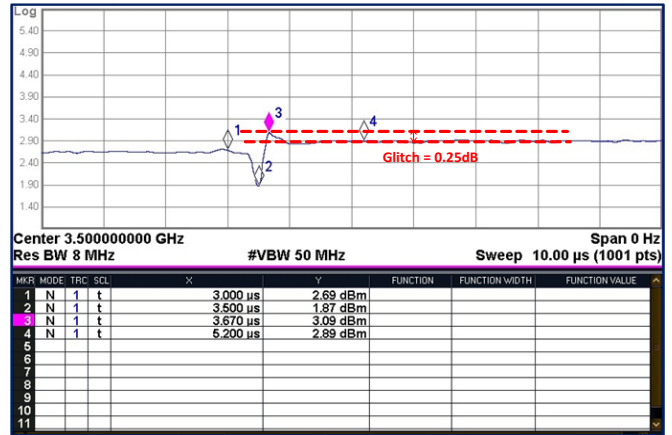

Figure 41. ATT Transient (16 to 15.75dB, Pin=18dBm)



Preliminary Datasheet

Typical RF Performance Plot - BDA4710V/BDA4710VT EVK - PCB (Optimized Return Loss Application

Typical Performance Data @ 25°C and $V_{DD} = 3.3V$, EVKit RF connector and board losses are de-embedded, unless otherwise noted

Table 14. Optimized Return Loss Application Circuits for 4GHz - 8.5GHz

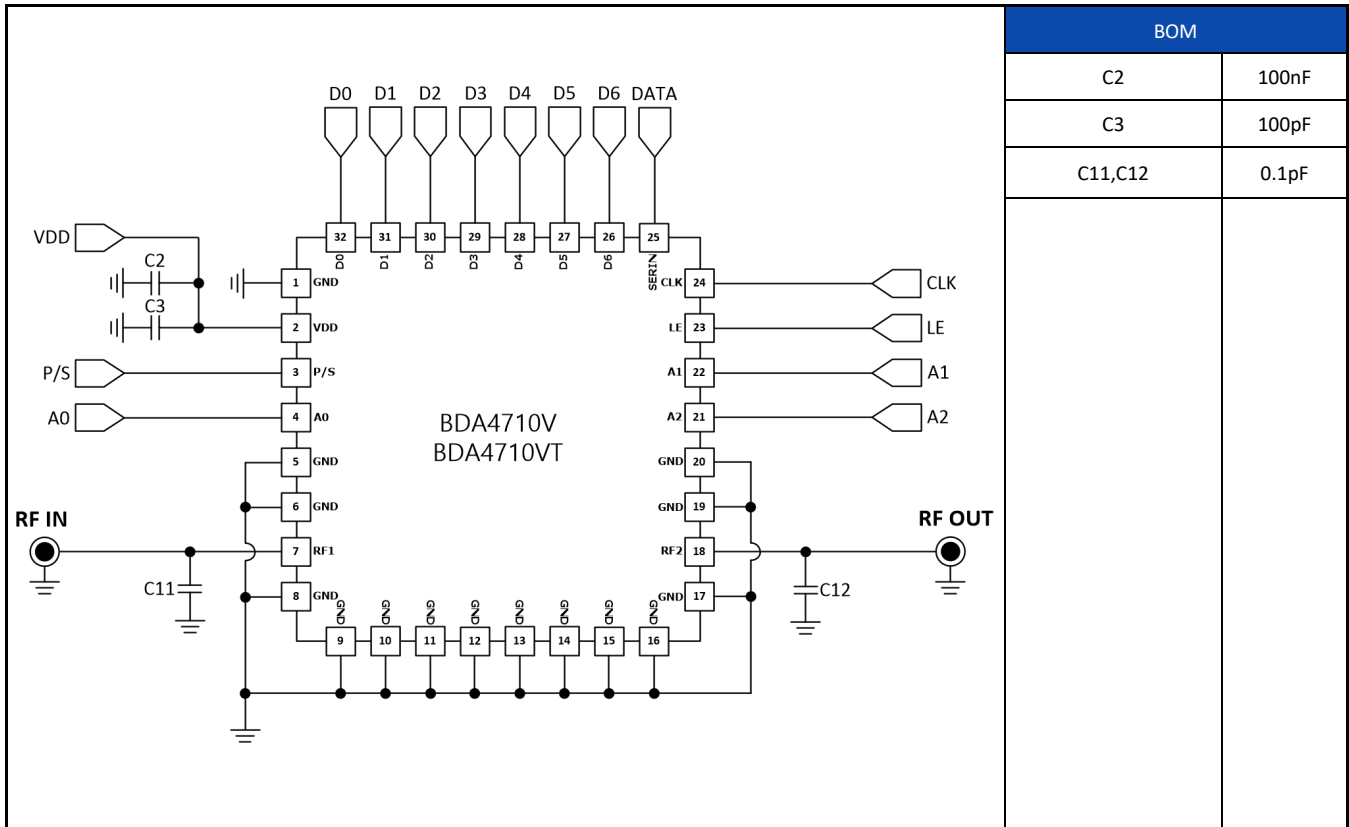

1. See the page 21 the Evaluation Board Circuits for the detailed application circuit information.
2. In order to optimized Return loss for above 4GHz, shunt capacitor 0.1pF was added near RF1 & RF2, respectively.

Figure 42. Insertion Loss vs Temp.

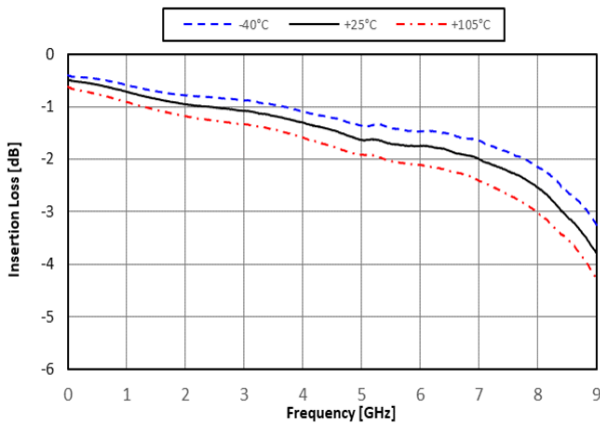
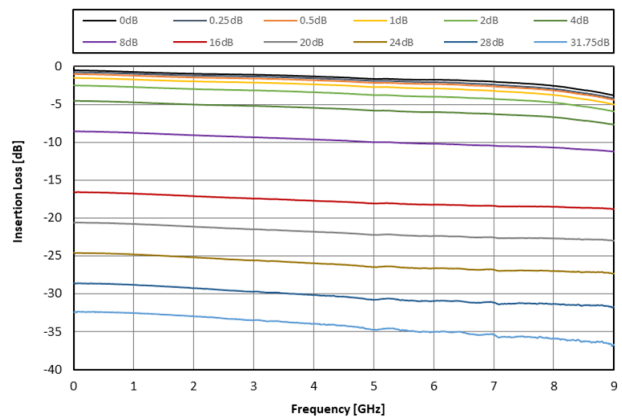
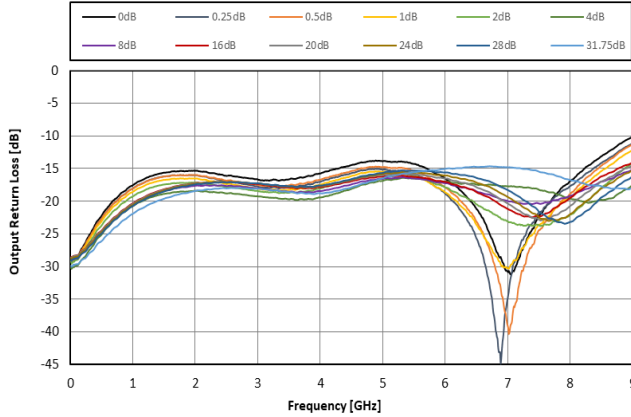
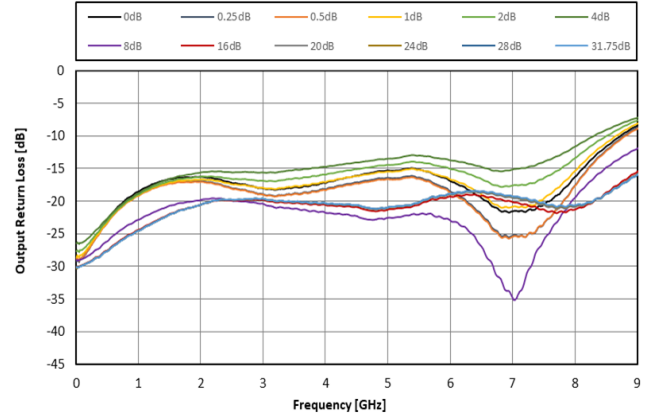
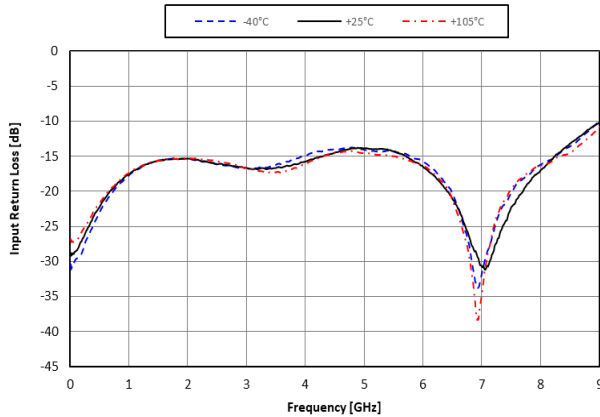
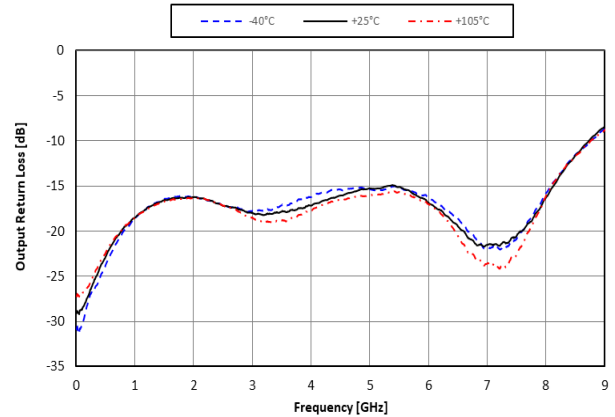
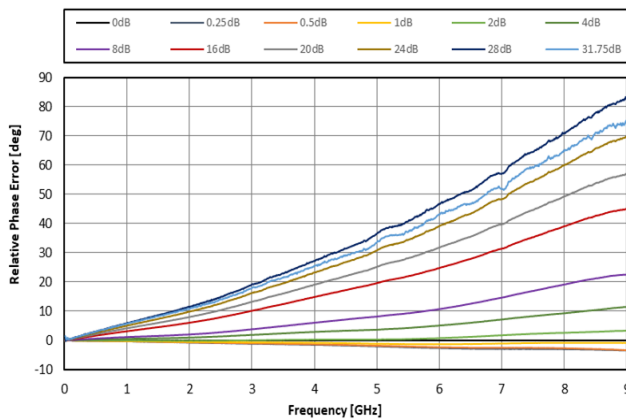
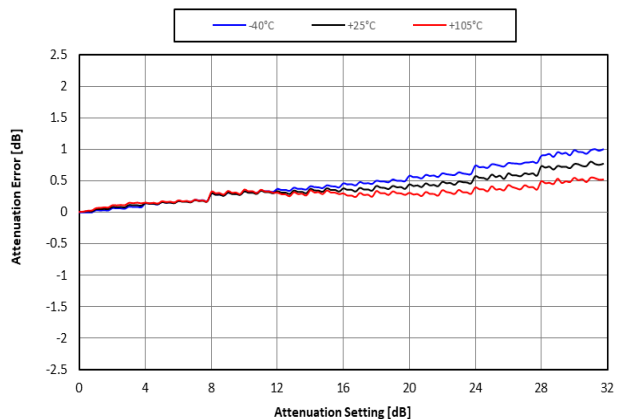

Figure 43. Insertion Loss vs ATT Setting



Typical RF Performance Plot - BDA4710V/BDA4710VT EVK - PCB (Optimized Return Loss Application

Typical Performance Data @ 25°C and V_{DD} = 3.3V, EVKit RF connector and board losses are de-embedded, unless otherwise noted

Figure 44. Input Return Loss vs ATT Setting

Figure 45. Output Return Loss vs ATT Setting

Figure 46. Input Return Loss vs Temp. @ ATT = 0dB

Figure 47. Output Return Loss vs Temp. @ ATT = 0dB

Figure 48. Relative Phase Error vs ATT Setting

Figure 49. ATT Error vs Temp. @ 3500MHz

Preliminary Datasheet

Typical RF Performance Plot - BDA4710V/BDA4710VT EVK - PCB (Optimized Return Loss Application

Typical Performance Data @ 25°C and $V_{DD} = 3.3V$, EVKit RF connector and board losses are de-embedded, unless otherwise noted

Figure 50. ATT Error vs Temp. @ 4600MHz

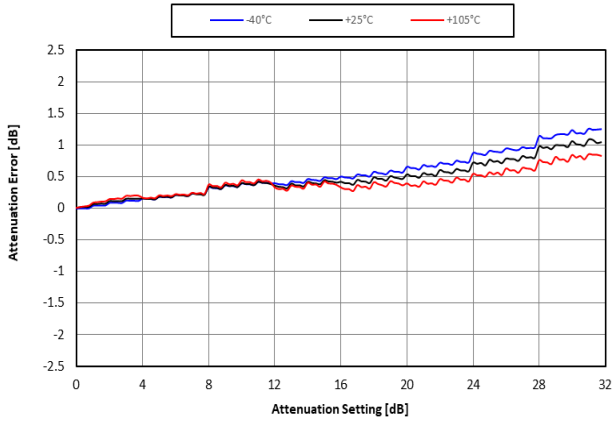

Figure 51. ATT Error vs Temp. @ 5800MHz

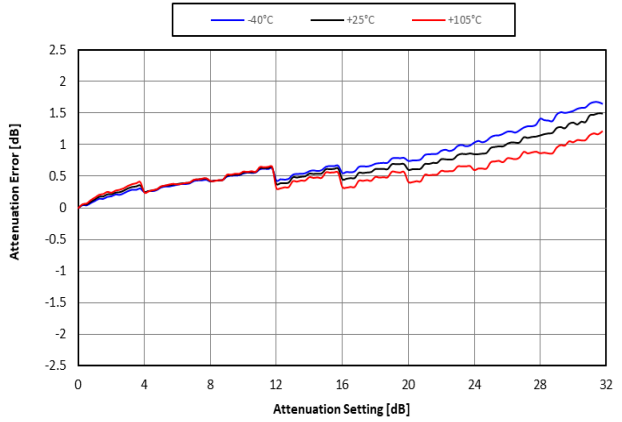

Figure 52. ATT Error vs Temp. @ 7200MHz

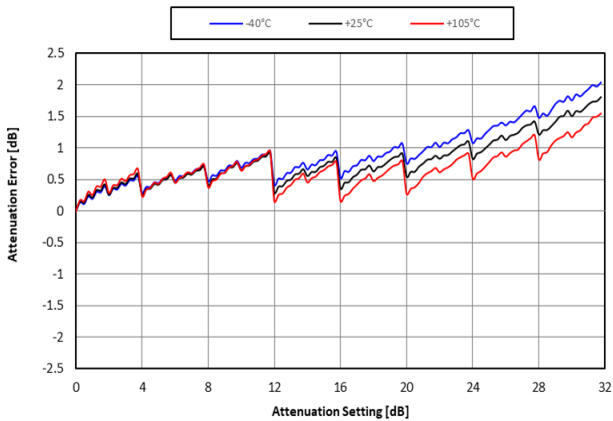

Figure 53. ATT Error vs Temp. @ 8500MHz

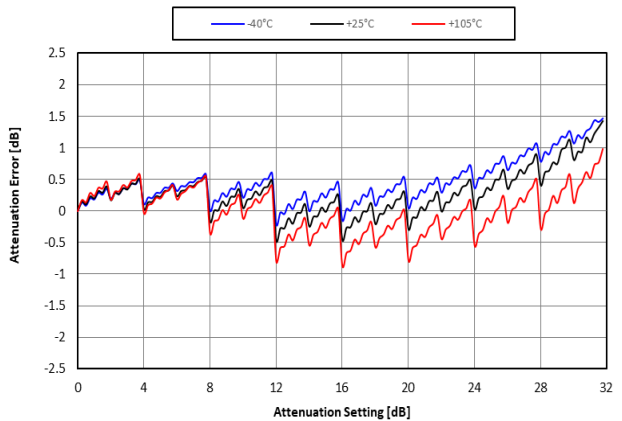

Figure 54. 0.25dB Step Actual ATT vs Frequency

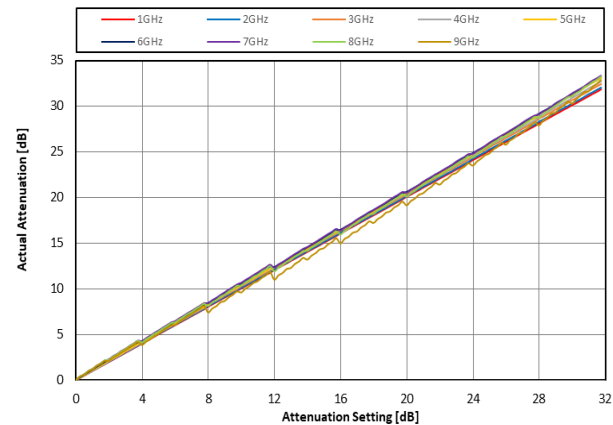
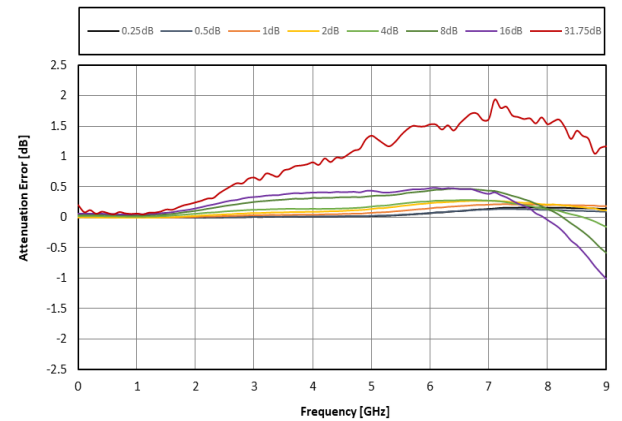

Figure 55. 0.25dB Major State Bit Error vs ATT Setting



Preliminary Datasheet

Typical RF Performance Plot - BDA4710V/BDA4710VT EVK - PCB (Optimized Return Loss Application

 Typical Performance Data @ 25°C and $V_{DD} = 3.3V$, EVKit RF connector and board losses are de-embedded, unless otherwise noted

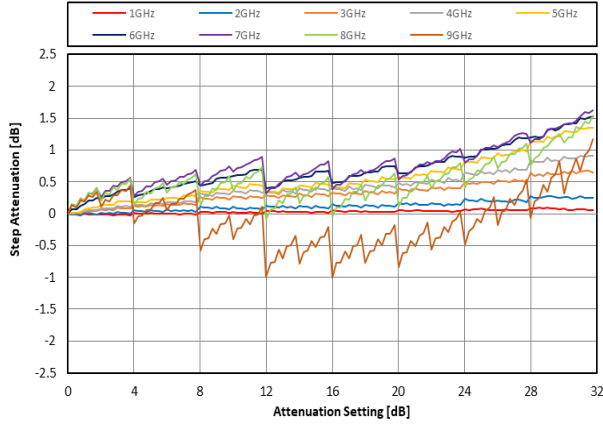
Figure 56. 0.25dB Step ATT Error vs Frequency

Preliminary Datasheet

BDA4710V/BDA4710VT Evaluation board Kit Description

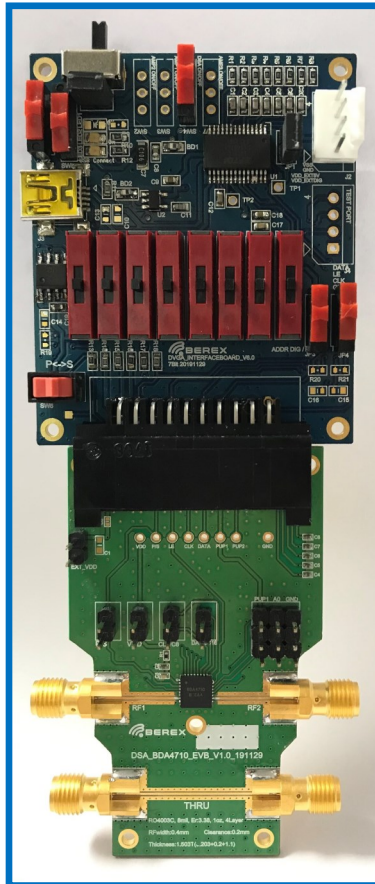

Figure 57. BDA4710V/BDA4710VT EVK

Evaluation board Kit Introduction

BDA4710V/BDA4710VT Evaluation Kit is made up of a combination of an RF board and an interface board

The schematic of the BDA4710V/BDA4710VT evaluation RF board is shown in Figure 57. The BDA4710V/BDA4710VT evaluation RF board is constructed of a 4-layer material with a copper thickness of 1oz(0.035mm) on each layer. Every copper layer is separated with a dielectric material. The top dielectric material is 8 mils RO4003. The middle and bottom dielectric materials are FR-4, used for mechanical strength and overall board thickness of approximately 1.63mm.

BDA4710V/BDA4710VT Evaluation INTERFACE board is assembled with a SP3T switches (D0~D6,LE), SP2T mechanical switch (P/S), and several header & switch.

Evaluation Board Programming Using USB Interface

In order to evaluate the BDA4710V/BDA4710VT performance, the Application Software has to be installed on your computer. And The DSA application software GUI supports Latched Parallel and Serial modes. software can be downloaded from BeRex’s website

Serial Control Mode

- Set the Address Jumper (A0, A1, A2) to HIGH or LOW (Refer to Address Table 9)
- Connect directly the Evaluation INTEFRACE board USB port(J3) to PC
- Set the direction of P<->S Switch to S direction (P/S Logic HIGH)
- Set the D0~D6,LE switch to the middle position.
- Operate the 0~31.75dB attenuation state in GUI and then control the DSA

Latched Parallel Control Mode

- Connect directly the Evaluation INTEFRACE board USB port(J3) to PC
- Set the direction of P<->S Switch to P direction (P/S Logic LOW)
- Set the D0~D6, LE switch to the middle position.
- Operate the 0~31.75dB attenuation state in GUI and then control the DSA

Direct Parallel Control Mode

- Set the direction of P<->S Switch to P direction (P/S Logic LOW)
- Set LE switch to the LOW Position
- For the setting to attenuation state, D0~D6 switches can be combined in manually program, refer to Table 11.

Please refer to user manual for more detailed operation method of BDA4710V/BDA4710VT EVK.

BDA4710V/BDA4710VT Evaluation board Kit Description

Figure 58. Evaluation Board Kit Schematic Diagram

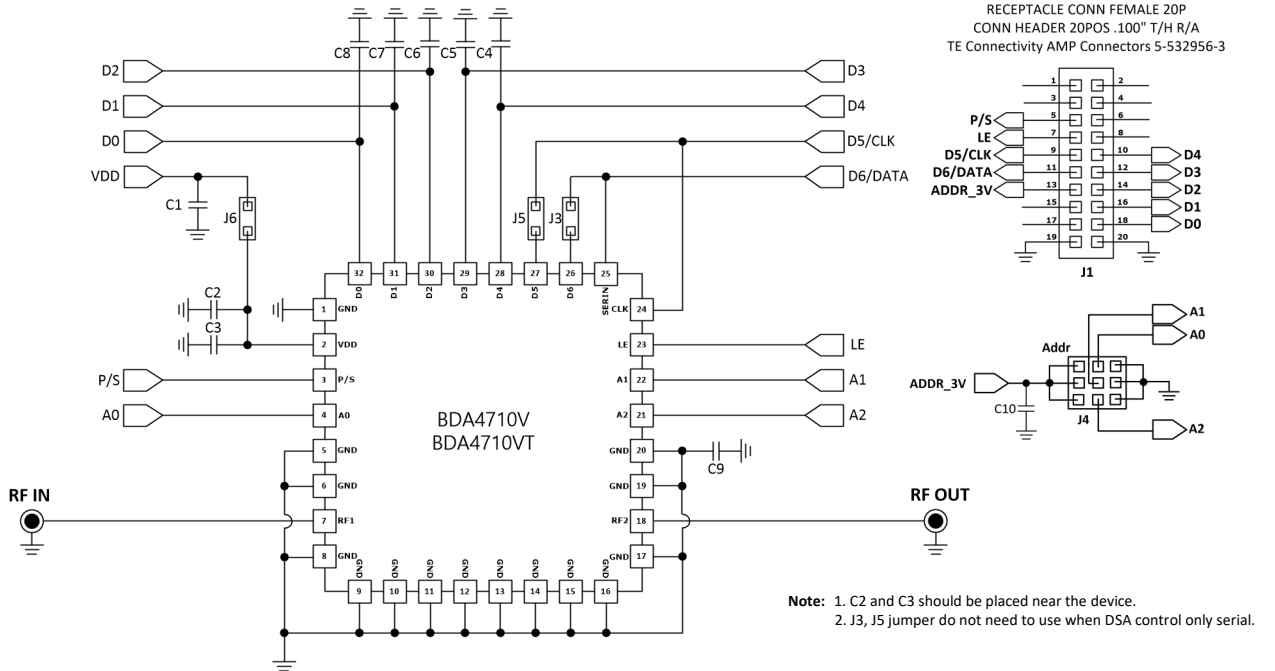

Figure 59. Evaluation Board PCB Layout Information

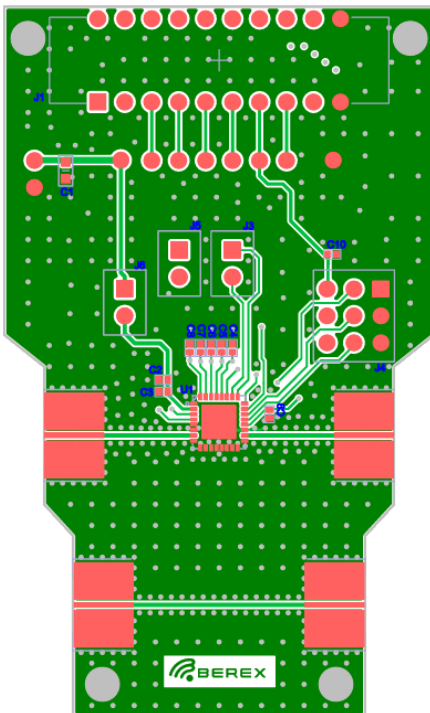

Table 15. Bill of Material - Evaluation Board

No.	Ref Des	Part Qty	Value	Description	Remark
1	C3-C8	6	100pF	CAP, 0402, CHIP Ceramic, ±0.25%	
2	C2,C10	2	100nF	CAP, 0402, CHIP Ceramic, ±0.25%	
3	C9	1	0 ohm	RES, 0402, CHIP, ±5%	
4	U1	1	Chip	DSA, BDA4710V/BDA4710VT QFN5x5 32L	
5	SMA1, SMA2	2	CON	SMA END LAUNCH	
6	J1	1	CON	Receptacle connector 20pin	
7	J2,J3,J5,J6	4	CON	Header 2.54mm 2pin	
8	J4	1	CON	Header array 2.54mm 3pin x 3	
9	C1	1	NC	Not Connected	

Figure 60. Evaluation Board PCB Layer Information

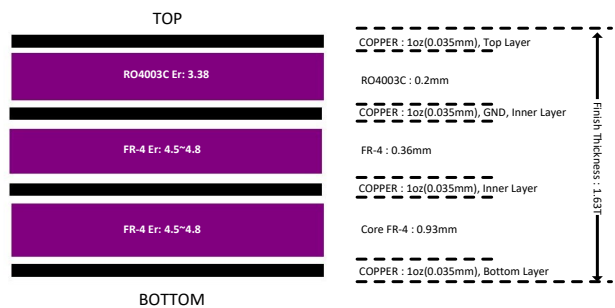
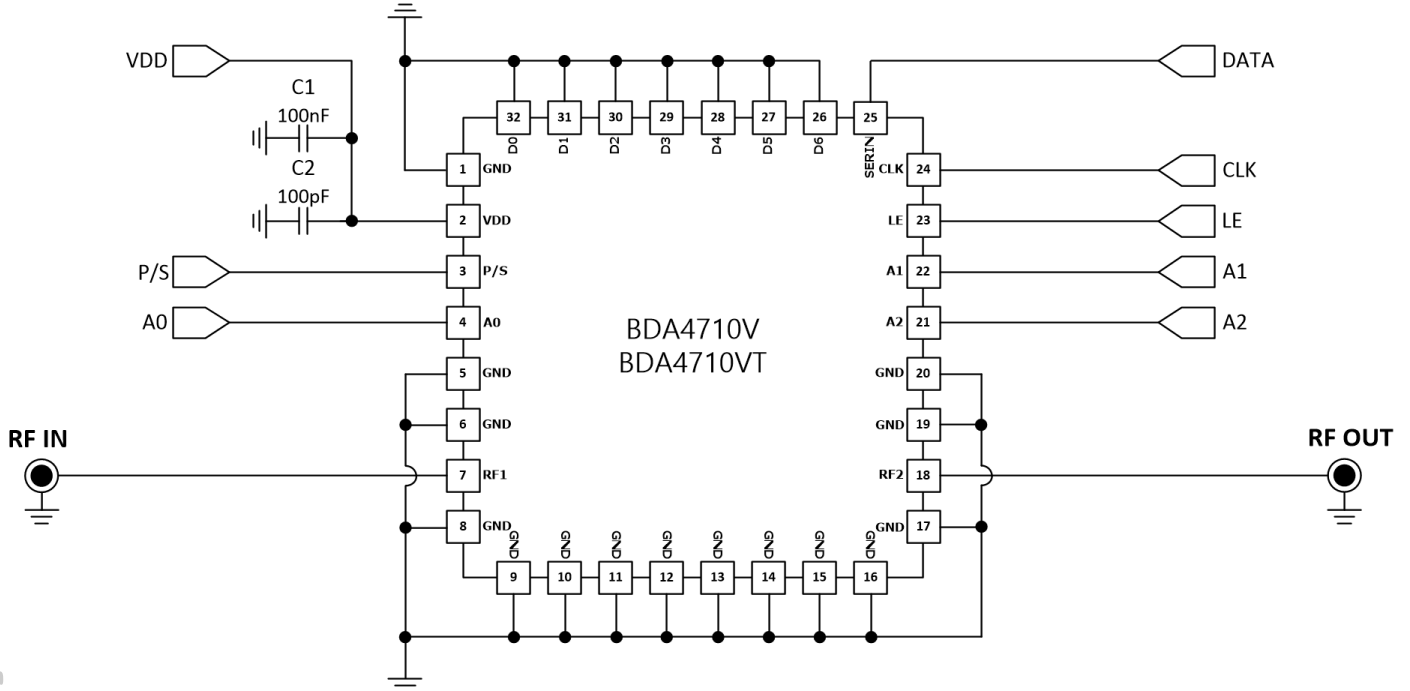
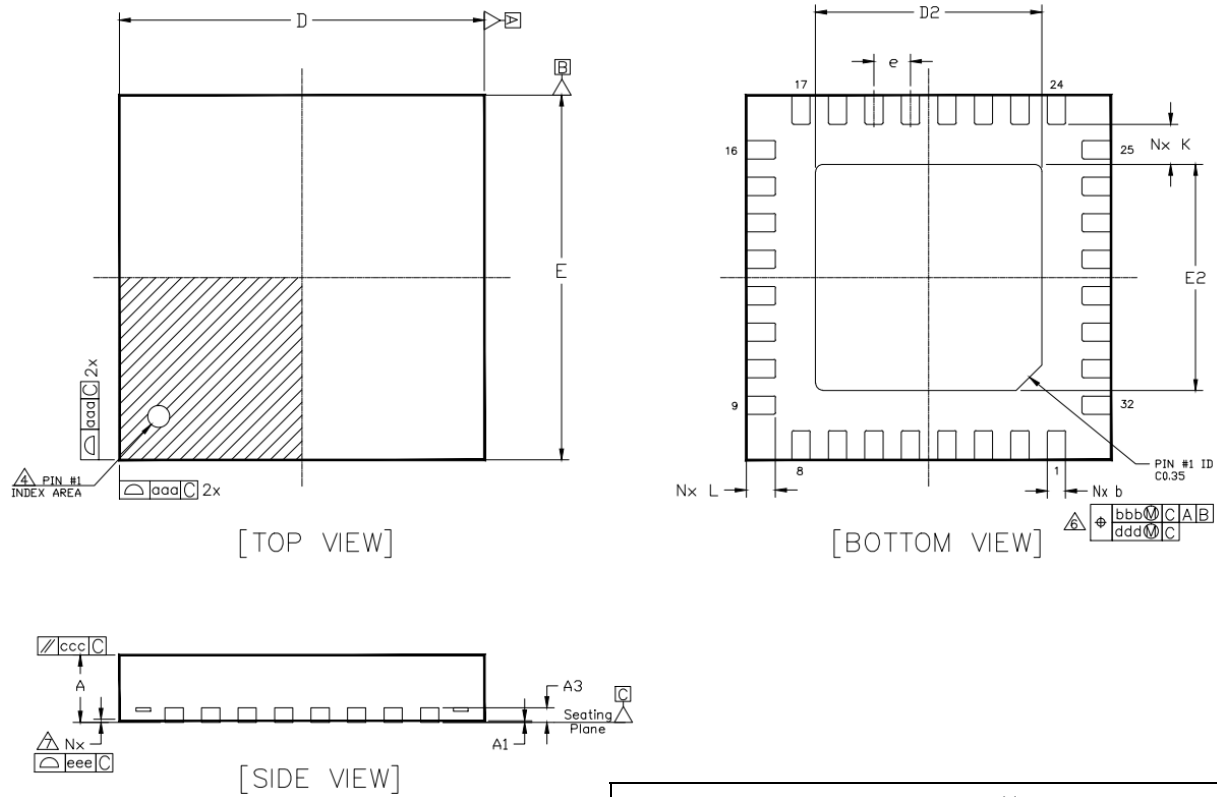

Figure 61. Recommended Serial mode Application Schematic

- Note:**
1. C1 and C2 should be placed near the device.
 2. Addressable Pin A0,A1,A2 can be set according to the specified address. If the specified address is 000, All addressable pin(A0,A1,A2) should be grounded.

Preliminary Datasheet

Figure 62. Packing Outline Dimension





NOTE :

1. Dimensioning and tolerancing conform to ASME Y14.5-2009.
2. All dimensions are in millimeters.
3. N is the total number of terminals.
4. The location of the marked terminal #1 identifier is within the hatched area.
5. ND and NE refer to the number of terminals on each D and E side respectively.
6. Dimension b applies to the metallized terminal and is measured between 0.15mm and 0.30mm from the terminal tip. If the terminal has a radius on the other end of it, dimension b should not be measured in that radius area.
7. Coplanarity applies to the terminals and all other bottom surface metallization

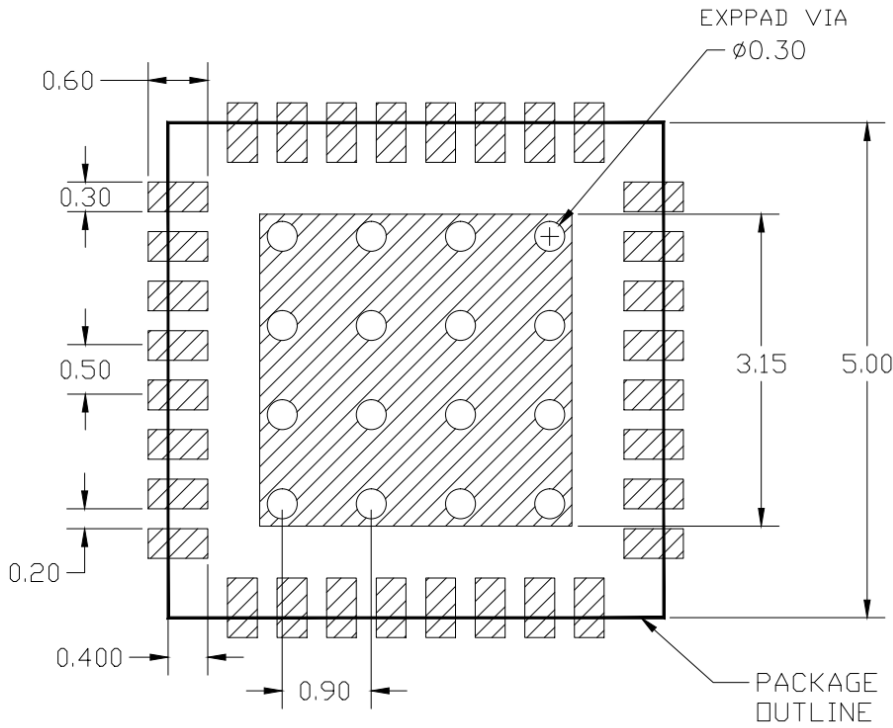
Dimension Table				
Symbol	Thickness			NOTE
	MINIMUM	NOMINAL	MAXIMUM	
A	0.8	0.9	1	
A1	0	0.02	0.05	
A3	---	0.203 Ref	---	
b	0.2	0.25	0.3	6
D		5.0 BSC		
D2	3.05	3.10	3.15	
E		5.0 BSC		
E2	3.05	3.10	3.15	
e		0.5 BSC		
K	0.2	---	---	
L	0.3	0.4	0.5	
aaa		0.05		
bbb		0.1		
ccc		0.1		
ddd		0.05		
eee		0.08		
N		32		3
ND		8		5
NE		8		5

Figure 63. Recommend Land Pattern

Figure 64. Package Marking

BDA4710V
YYWWXX

BDA4710T
YYWWXX

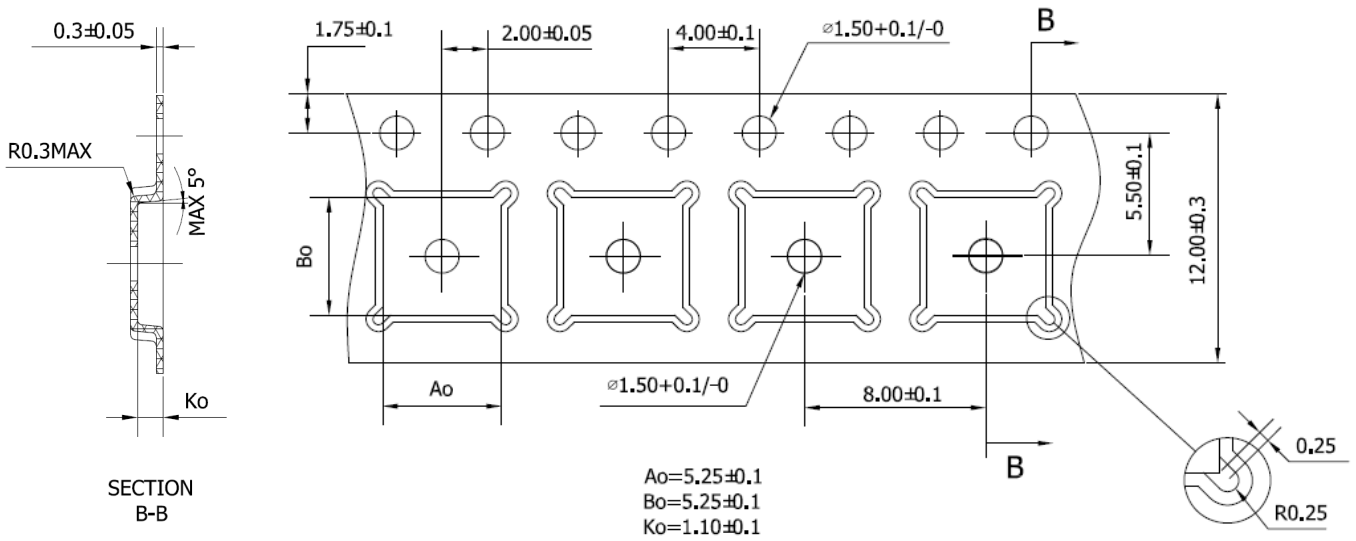
Marking information:	
BDA4710V	Device Name : BDA4710V
BDA4710T	Device Name : BDA4710VT
YY	Year
WW	Work Week
XX	LOT Number

Figure 65. Tape & Reel

NOTES:

- 1 10 SPROCKET HOLE PITCH CUMULATIVE TOLERANCE ± 0.2
- 2 CAMBER IN COMPLIANCE WITH EIA 481
- 3 POCKET POSITION RELATIVE TO SPROCKET HOLE MEASURED AS TRUE POSITION OF POCKET, NOT POCKET HOLE

Packaging information:

Tape Width	12mm
Reel Size	7inch
Device Cavity Pitch	8mm
Devices Per Reel	1k

Lead plating finish

100% Tin Matte finish

(All BeRex products undergoes a 1 hour, 150 degree C, Anneal bake to eliminate thin whisker growth concerns.)

MSL / ESD Rating

ESD Rating: Class 1C
Value: ±1000V
Test: Human Body Model (HBM)
Standard: JEDEC Standard JS-001-2017

ESD Rating: Class C3
Value: ±1000V
Test: Charged Device Model (CDM)
Standard: JEDEC Standard JS-002-2018

MSL Rating: Level 1 at +260°C convection reflow
Standard: JEDEC Standard J-STD-020



Proper ESD procedures should be followed when handling this device.

RoHS Compliance

This part is compliant with Restrictions on the use of certain Hazardous Substances in Electrical and Electronic Equipment (RoHS) Directive 2011/65/EU as amended by Directive 2015/863/EU.

This product also is compliant with a concentration of the Substances of Very High Concern (SVHC) candidate list which are contained in a quantity of less than 0.1%(w/w) in each components of a product and/or its packaging placed on the European Community market by the BeRex and Suppliers.

NATO CAGE code:

2	N	9	6	F
---	---	---	---	---