

#### Device Features

- +29.7 dBm Input IP3 @3.5G
- 9.1 dB Conversion Loss @3.5G
- Integrated LO Driver
- -2 to +2 dBm LO drive level
- Available 3.3 V to 5 V single voltage
- MSL 3, TDFN-8L 3x3, Lead-free / Green / RoHS compliant
- ESD HBM Class 1A

#### Package Type



TDFN 8-Lead 3x3 mm

#### Product Description

The BM351 is a high linearity and dynamic covering range from 2.5 GHz to 6.0 GHz on 3.3 V to 5 V with a passive GaAs FET converter and two stage LO driver. This is packaged in a plastic surface mountable TDFN-8Lead 3x3 with Lead-free / Green / RoHS compliant. Typical Input IP3 and Conversion loss are 32 dBm and 8.8dB, respectively. All devices are 100% RF/DC screened.

#### Application Circuit

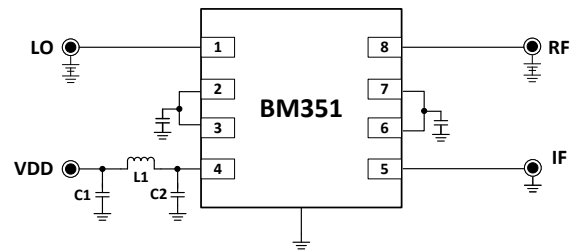

IF Frequency	BOM	Value
100~500 MHz	C1	N/C
	C2	1nF
	L1	27nH

#### Applications

- Base station /Repeaters Infrastructure/Small Cell
- Commercial/Industrial/Military wireless system
- 5G/LTE / WCDMA /CDMA Wireless Infrastructure
- MMD & wireless LAN

#### Functional Block Diagram

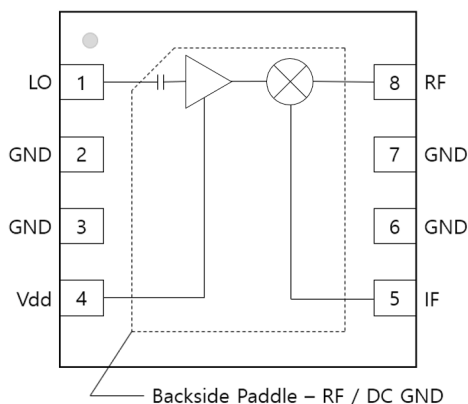

#### Absolute Maximum Ratings

Parameter	Rating	Unit
Operating Case Temperature	-40 to +105	°C
Storage Temperature	-55 to +155	°C
Junction Temperature	126	°C
Operating Voltage	7	V
LO Power	10	dBm
Input RF/IF Power	25	dBm

Operation of this device above any of these parameters may result in permanent damage.

#### Typical Performance<sup>1</sup>

Test condition \_ Measured on BeRex E/B at 25°C, 50ohm system, Vdd=5V Ids=85mA

Parameter	Min	Typ	Max	Min	Typ	Max	Min	Typ	Max	Min	Typ	Max	Units
RF Frequency Range	2500~2700			3300~3700			4600~4800			5500~6000			MHz
LO Frequency Range	2300~2650			2800~3600			4100~4700			5000~5900			MHz
IF Frequency Range	50~200			50~700			50~700			50~700			MHz
SSB Conversion Loss		8.7			9.1			8.5			9.5		dB
Input IP3 <sup>2</sup>		26.7			29.7			34.8			31.6		dBm
LO Leakage RF Port		-13.1			-0.1			4.9			-0.3		dBm
LO Leakage IF Port		-21.9			-24.9			-16.5			-16.4		dBm
RF-IF Isolation		-31.6			-38.0			-30.1			-29.1		dB
RF Return Loss		-7.4			-22.0			-14.1			-13.4		dB
IF Return Loss		-7.2			-4.4			-5.6			-19.0		dB
Input P1dB		17.1			22.1			24.1			19.7		dBm
LO Drive Level	-2	0	2	-2	0	2	-2	0	2	-2	0	2	dBm

Test condition \_ Measured on BeRex E/B at 25°C, 50ohm system, Vdd=3.3V Ids= 62mA

Parameter	Min	Typ	Max	Min	Typ	Max	Min	Typ	Max	Min	Typ	Max	Units
RF Frequency Range	2500~2700			3300~3700			4600~4800			5500~6000			MHz
LO Frequency Range	2300~2650			2800~3600			4100~4700			5000~5900			MHz
IF Frequency Range	50~200			50~700			50~700			50~700			MHz
SSB Conversion Loss		8.8			8.6			8.3			10.8		dB
Input IP3 <sup>2</sup>		25.9			25.8			35.6			24.9		dBm
LO Leakage RF Port		-13.8			-3.3			1.2			-6.2		dBm
LO Leakage IF Port		-24.1			-26.0			-18.7			-18.3		dBm
RF-IF Isolation		-31.7			-38.6			-30.7			-30.0		dB
RF Return Loss		-7.8			-20.2			-12.3			-12.1		dB
IF Return Loss		-7.4			-5.6			-6.4			-17.2		dB
Input P1dB		16.1			19.6			21.1			15.6		dBm
LO Drive Level	-2	0	2	-2	0	2	-2	0	2	-2	0	2	dBm

Parameter	Min.	Typical	Max.	Unit
Bandwidth	2500		6000	MHz
I <sub>d</sub> @ (V <sub>d</sub> = 5.0V)		85		mA
I <sub>d</sub> @ (V <sub>d</sub> = 3.3V)		62		mA
R <sub>TH</sub>		99		°C/W

<sup>1</sup>Specifications show on 0dBm-LO driven power and 200 MHz-IF frequency in a down converting configuration with high-side LO.

<sup>2</sup>IIP3 is measured on two tone with RF in power 0dBm/ tone , F<sub>2</sub>—F<sub>1</sub> = 1 MHz.

#### Typical Test Data : 5V, RF to IF Converting

Test condition : Measured on BeRex E/B at 25°C, 50ohm system, Vdd=5V, I<sub>ds</sub>=85mA , Down converting

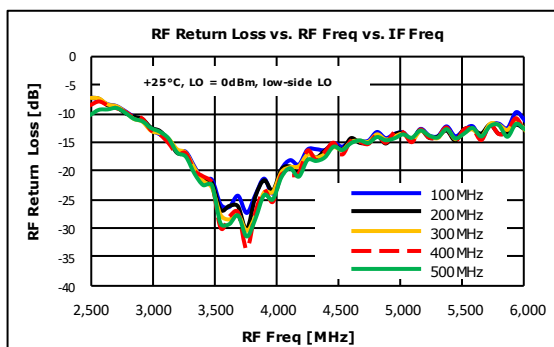
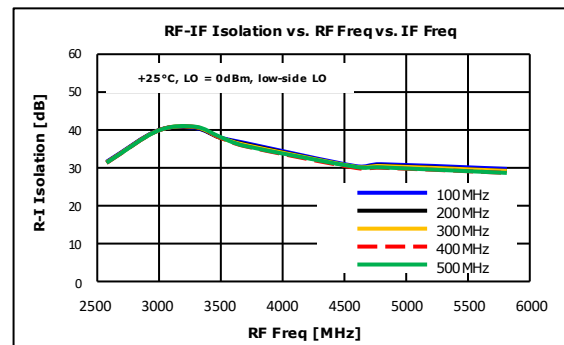
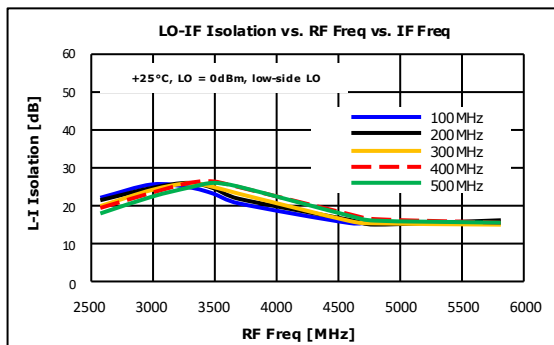
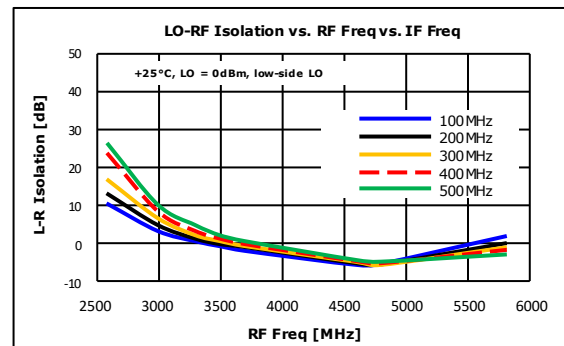
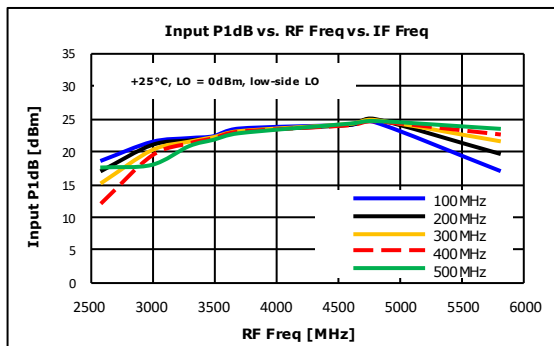
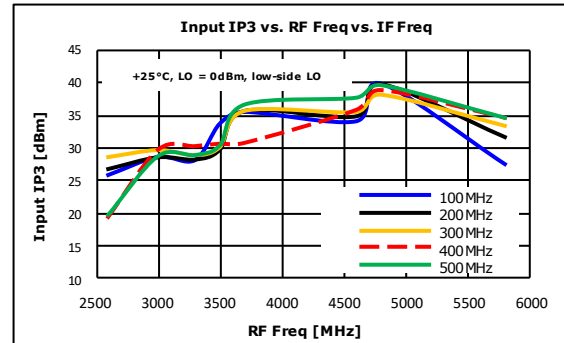
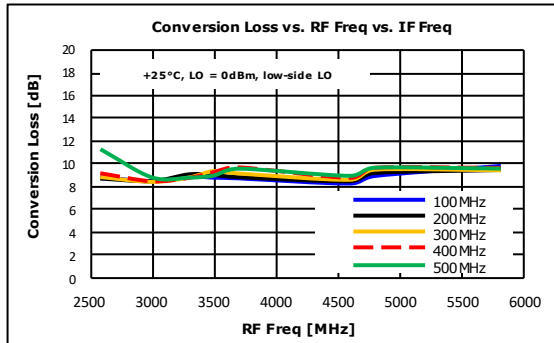

Preliminary Datasheet

#### Typical Test Data : 5V, RF to IF Converting

Test condition : Measured on BeRex E/B at 25°C, 50ohm system, Vdd=5V, I<sub>ds</sub>=85mA , Down converting

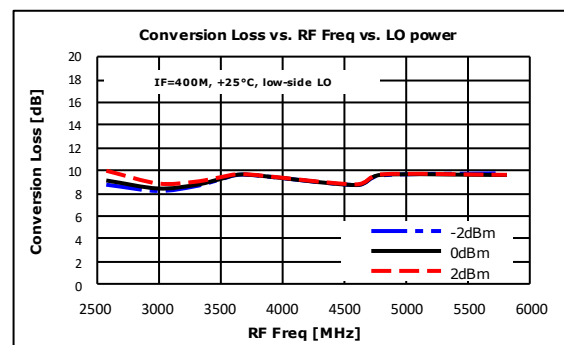
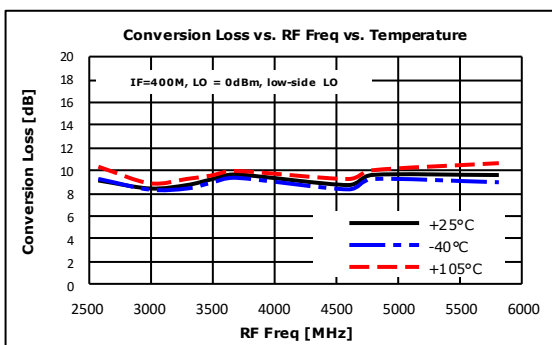
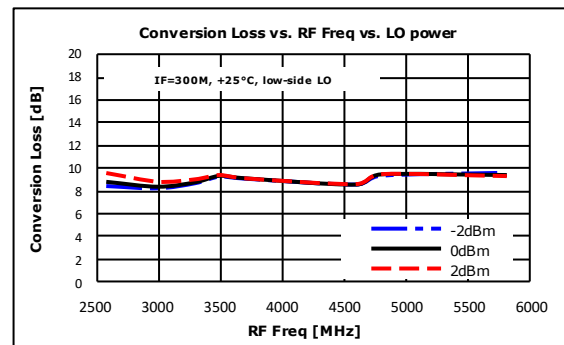
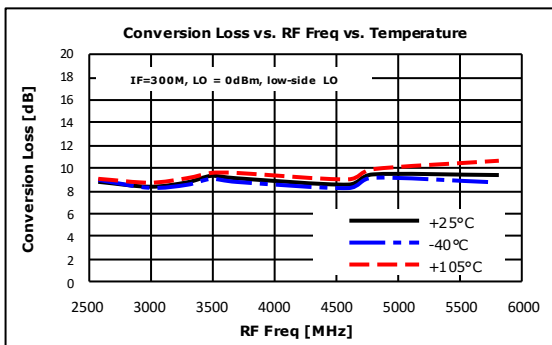
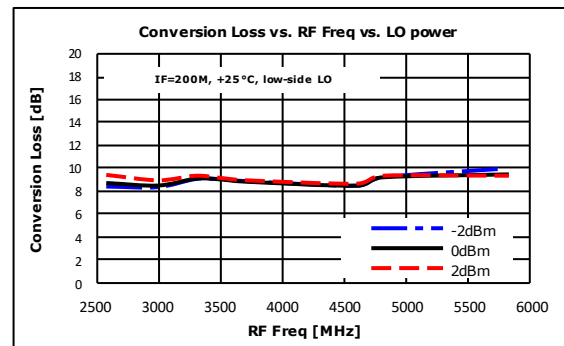
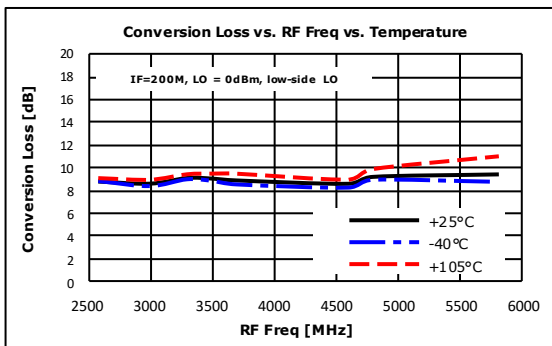
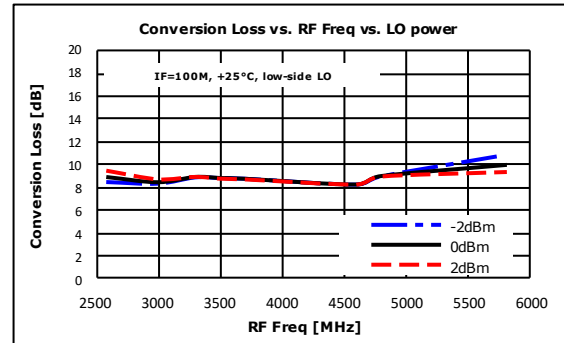
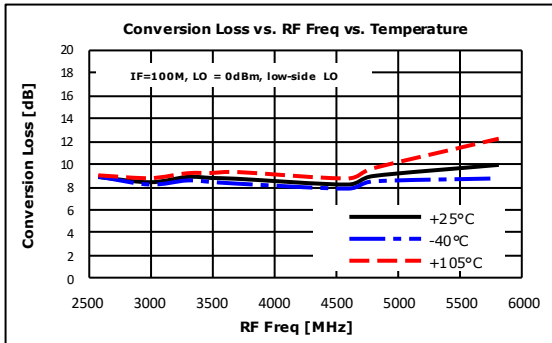

Preliminary Datasheet

#### Typical Test Data : 5V, RF to IF Converting

Test condition : Measured on BeRex E/B at 25°C, 50ohm system, Vdd=5V, I<sub>ds</sub>=85mA , Down converting

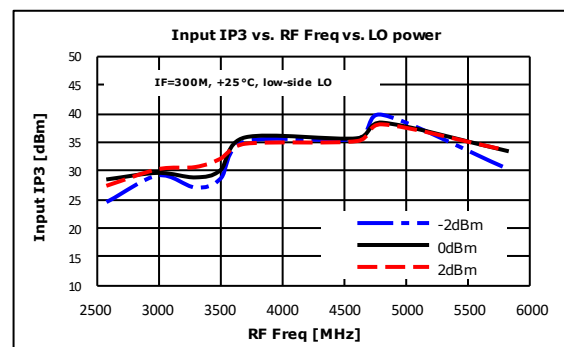
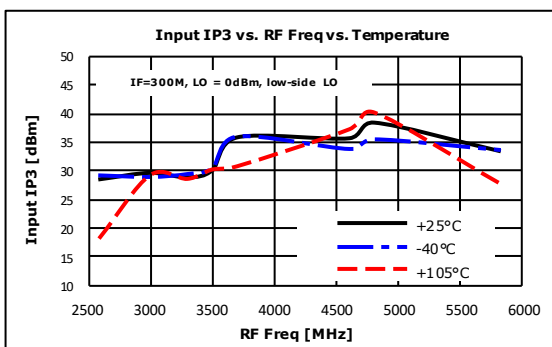
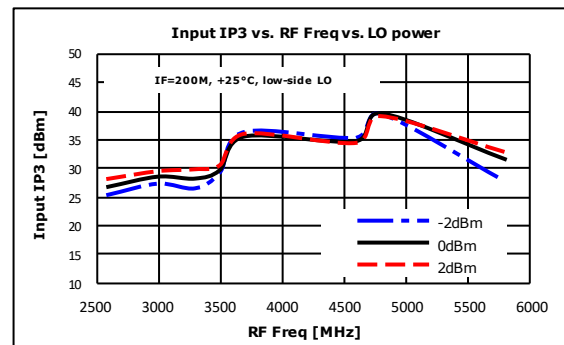
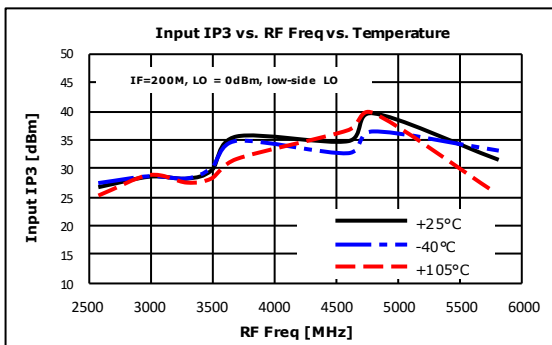
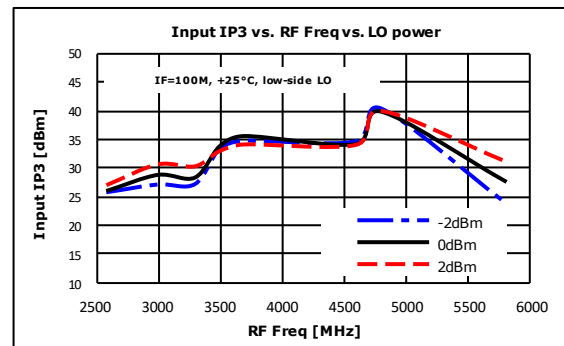
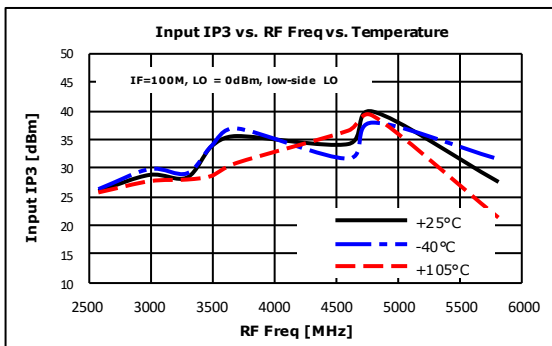
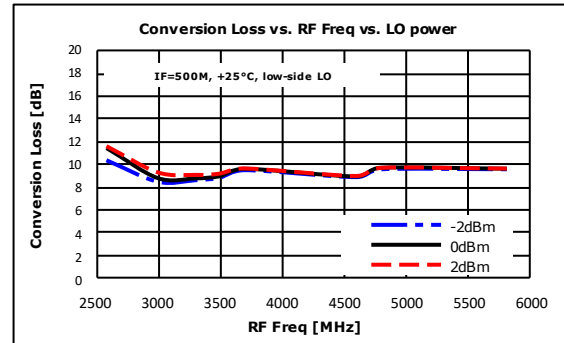
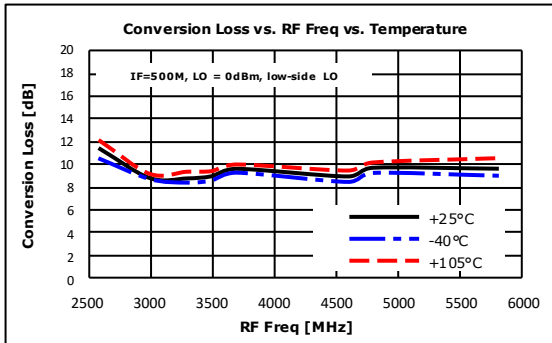

Preliminary Datasheet

#### Typical Test Data : 5V, RF to IF Converting

Test condition : Measured on BeRex E/B at 25°C, 50ohm system, Vdd=5V, I<sub>ds</sub>=85mA , Down converting

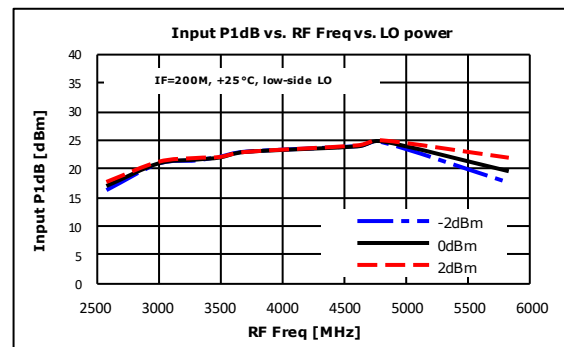
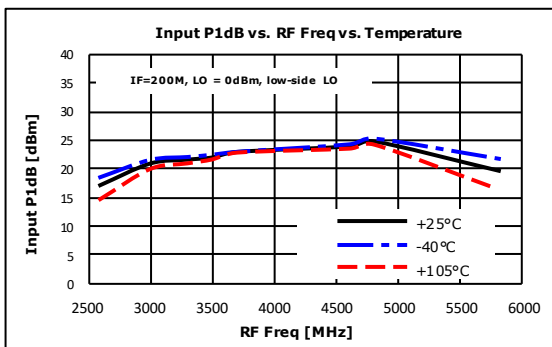
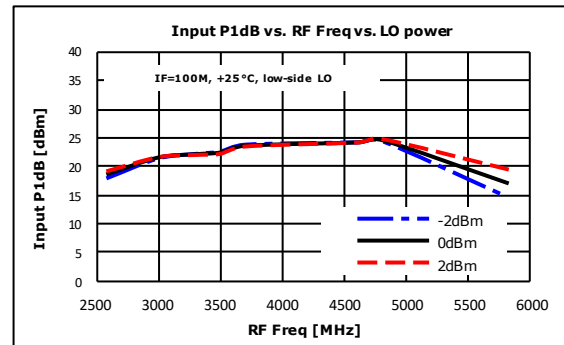
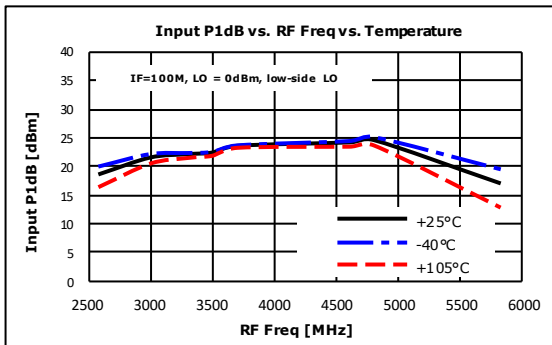
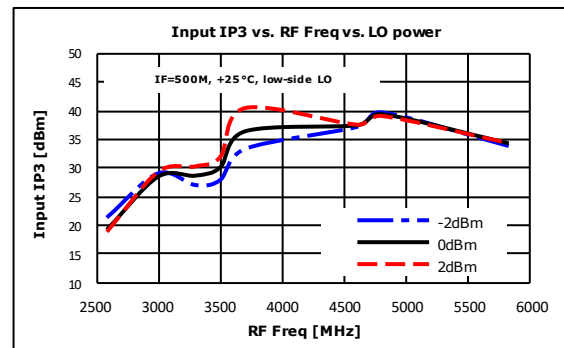
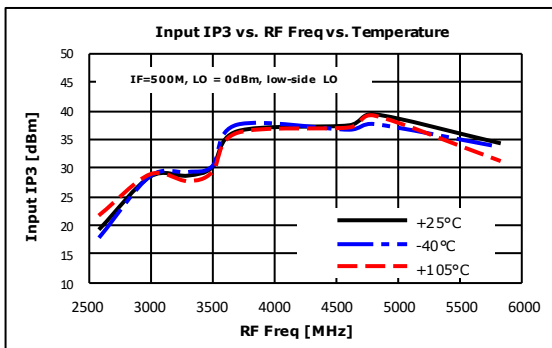
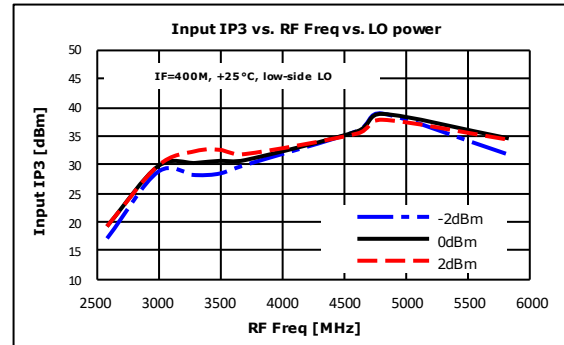
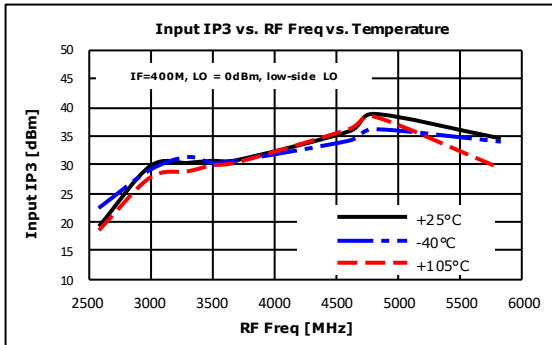

Preliminary Datasheet

**Typical Test Data : 5V, RF to IF Converting**

Test condition : Measured on BeRex E/B at 25°C, 50ohm system, Vdd=5V, Ids=85mA , Down converting

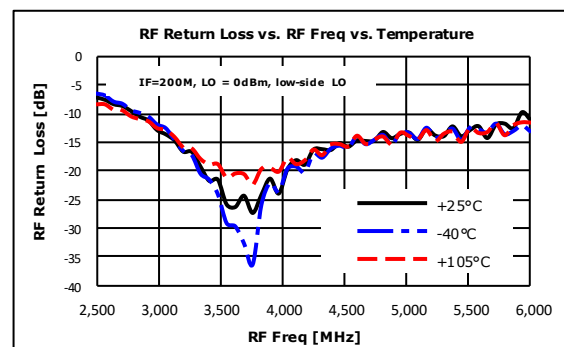
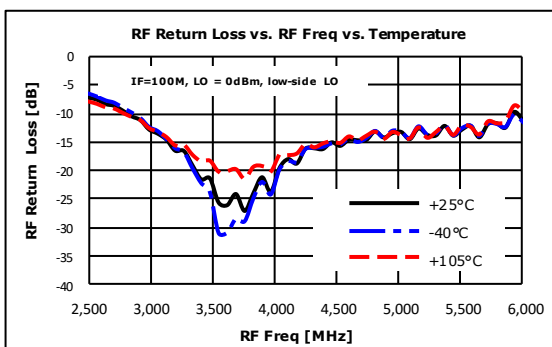
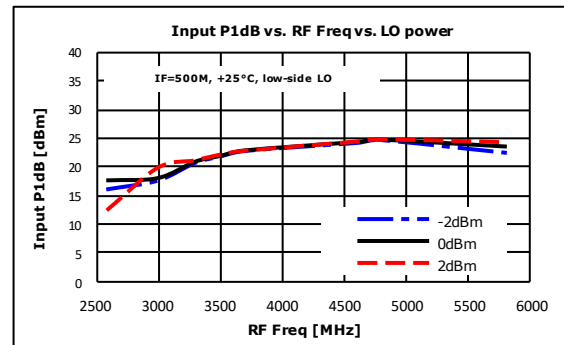
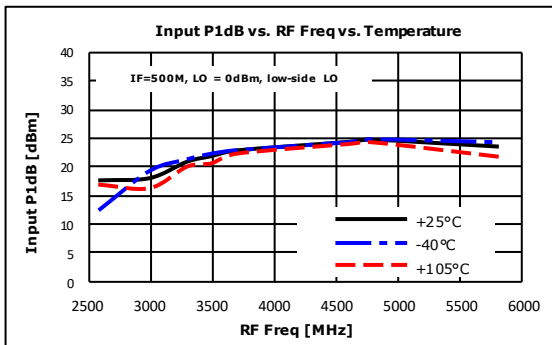
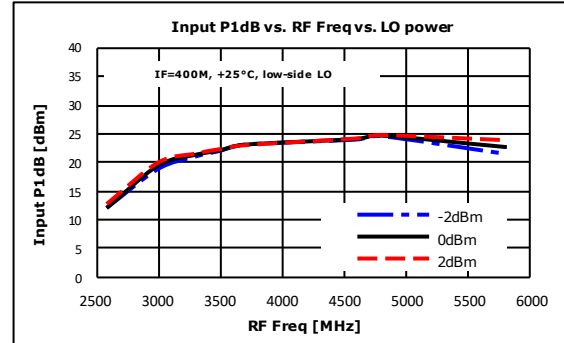
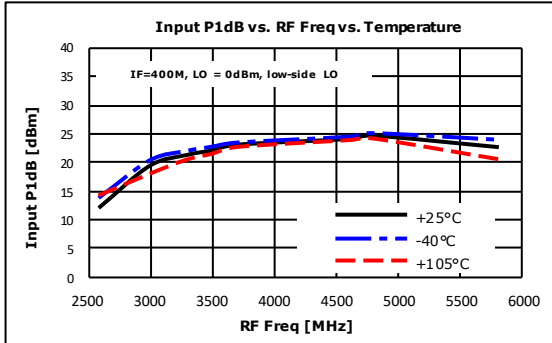
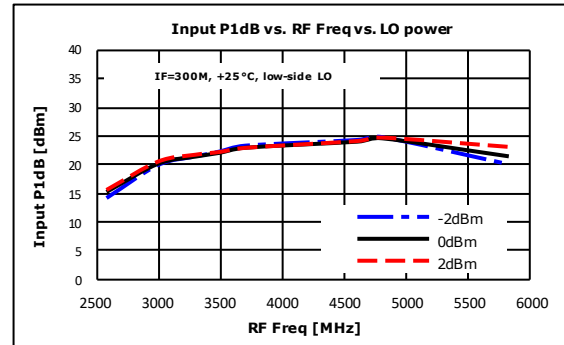
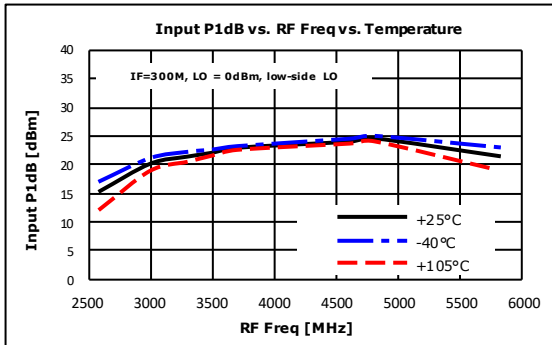

Preliminary Datasheet

#### Typical Test Data : 5V, RF to IF Converting

Test condition : Measured on BeRex E/B at 25°C, 50ohm system, Vdd=5V, I<sub>ds</sub>=85mA , Down converting

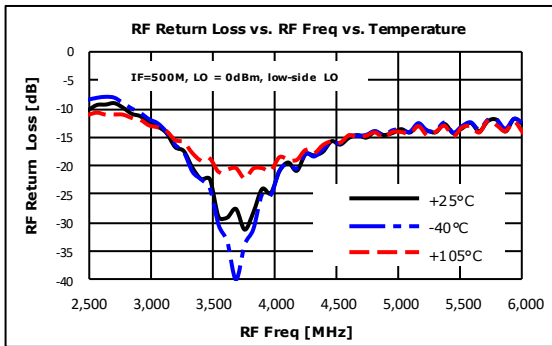
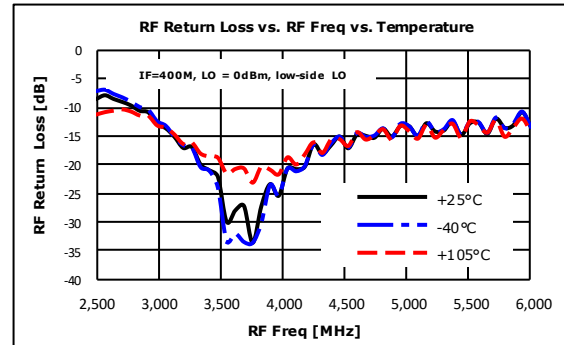
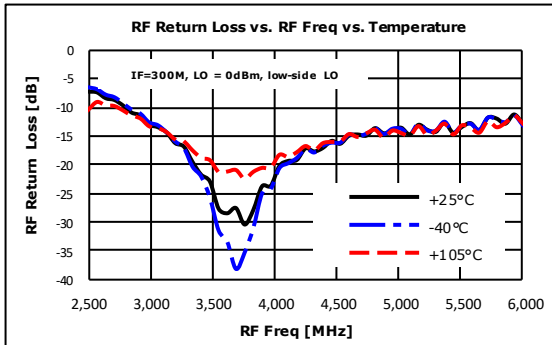



#### Typical Test Data : 5V, IF to RF Converting

Test condition : Measured on BeRex E/B at 25°C, 50ohm system, Vdd=5V, I<sub>ds</sub>=85mA , Up converting

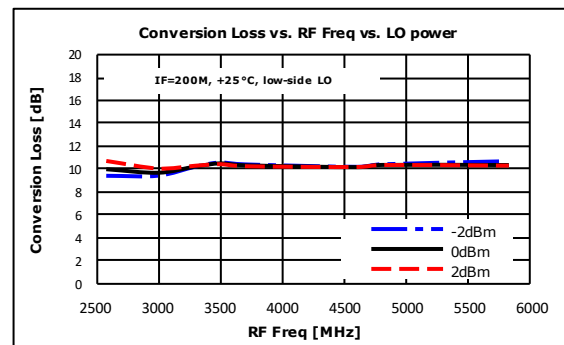
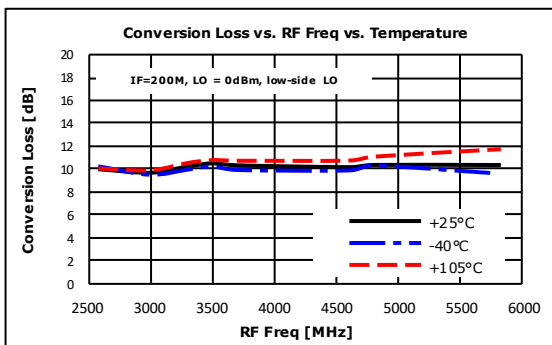
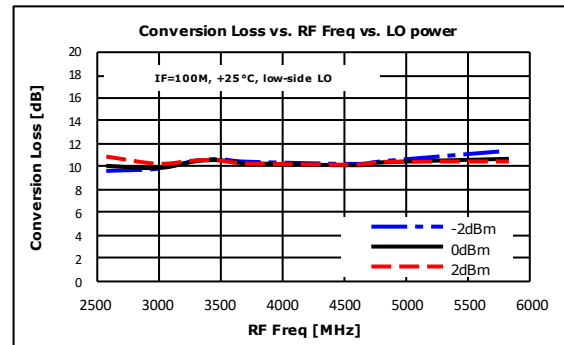
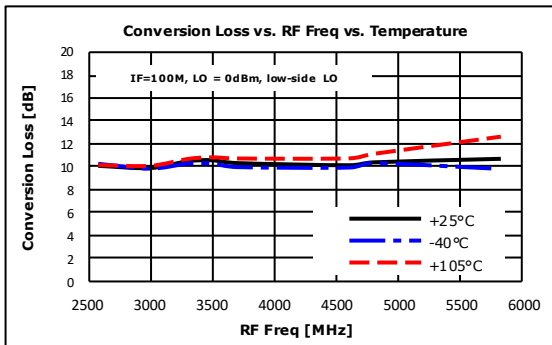
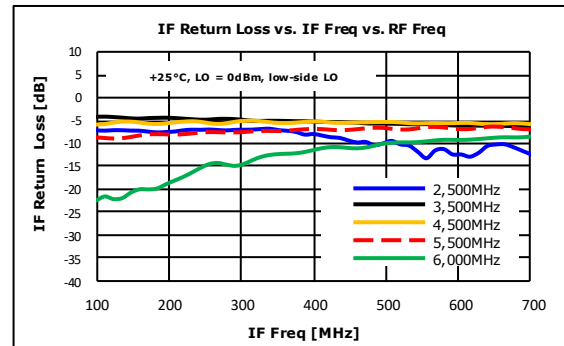
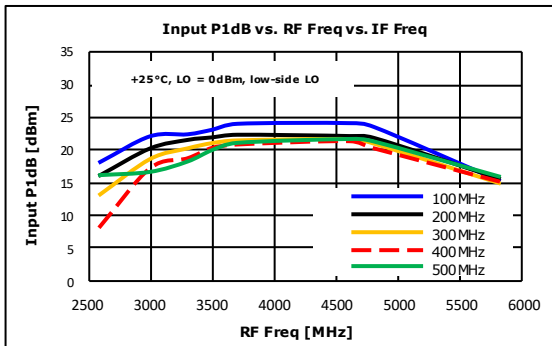
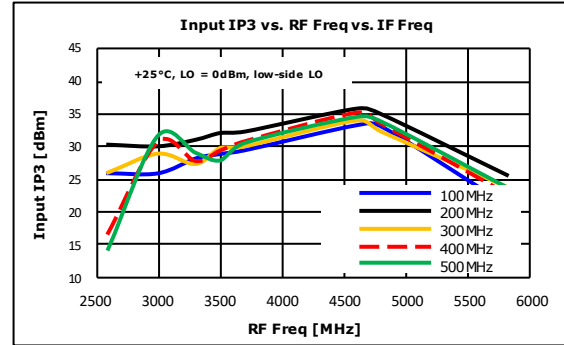
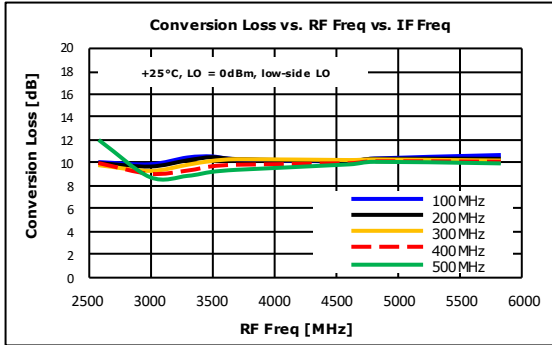

Preliminary Datasheet

#### Typical Test Data : 5V, IF to RF Converting

Test condition : Measured on BeRex E/B at 25°C, 50ohm system, Vdd=5V, I<sub>ds</sub>=85mA , Up converting

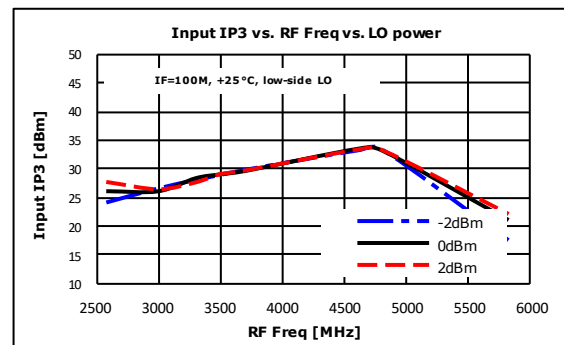
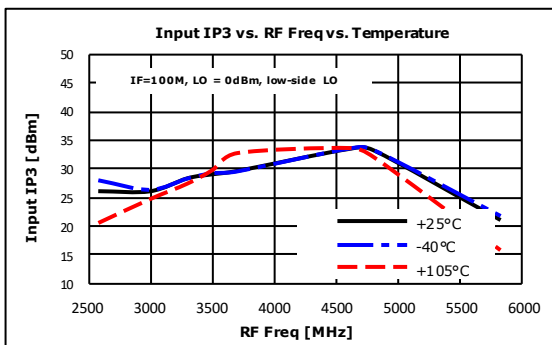
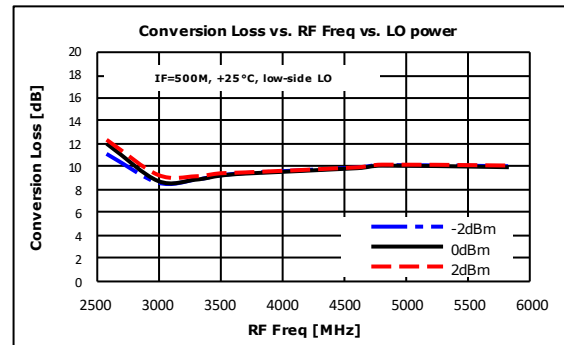
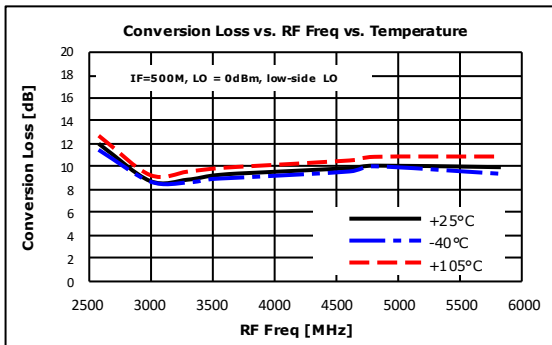
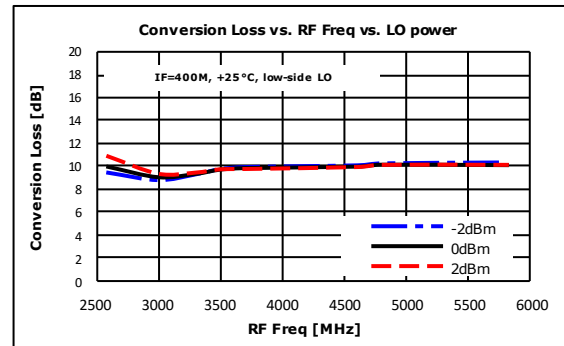
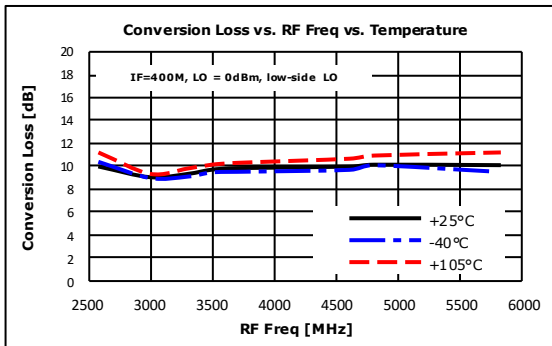
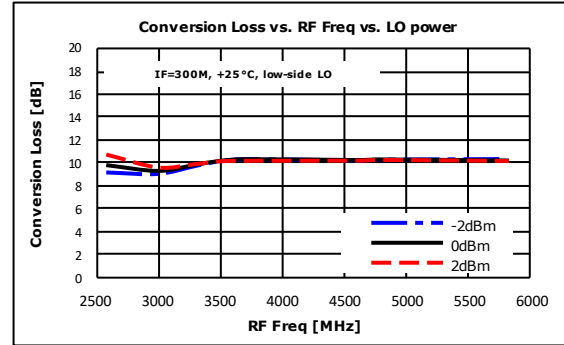
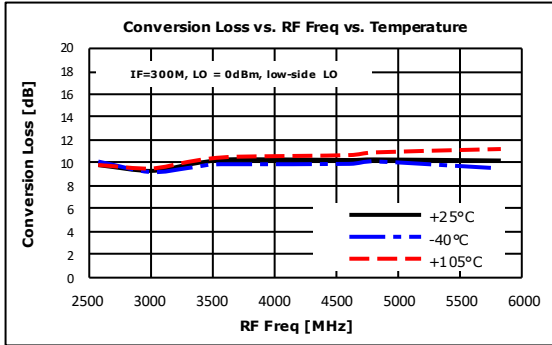

Preliminary Datasheet

**Typical Test Data : 5V, IF to RF Converting**

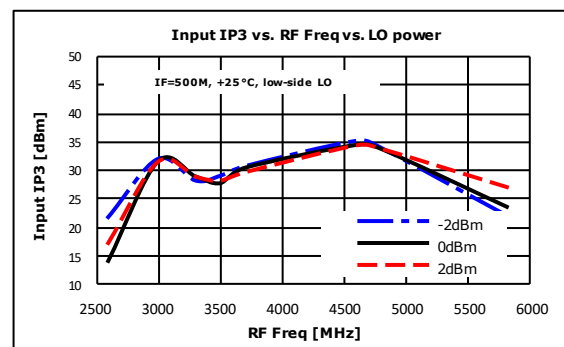
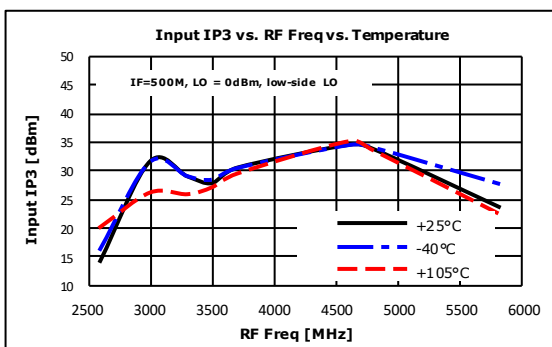
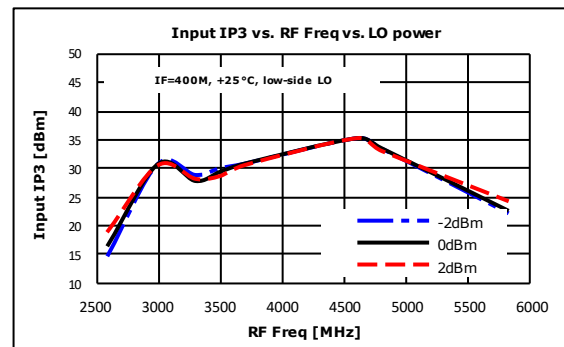
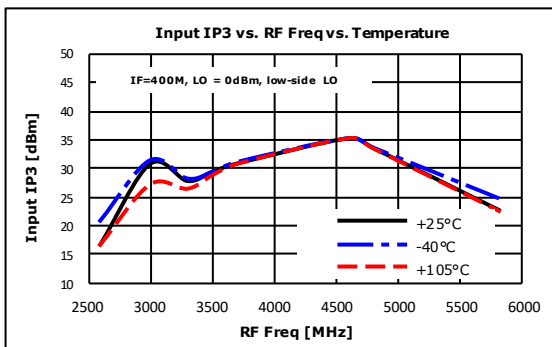
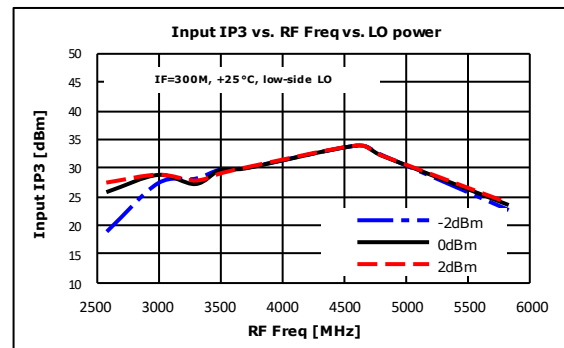
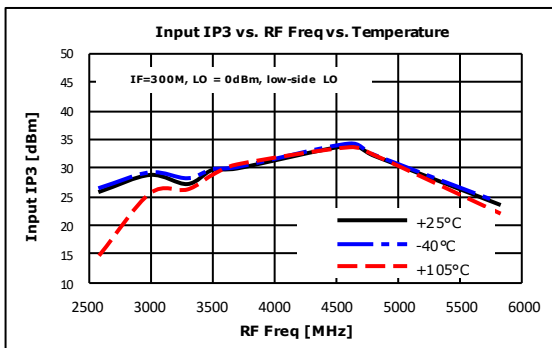
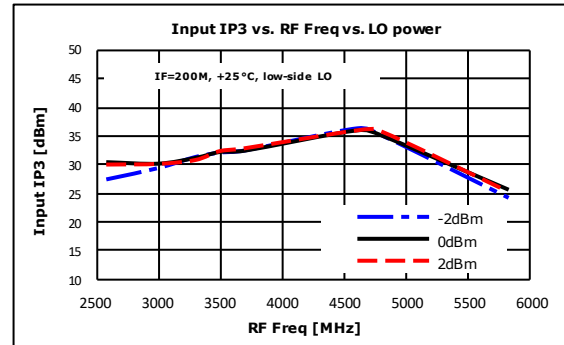
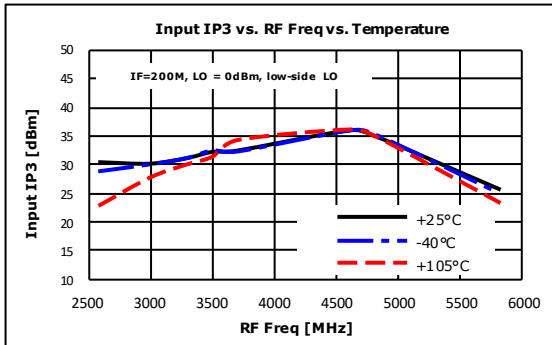
 Test condition : Measured on BeRex E/B at 25°C, 50ohm system, Vdd=5V, I<sub>ds</sub>=85mA , Up converting

Preliminary Datasheet

**Typical Test Data : 5V, IF to RF Converting**

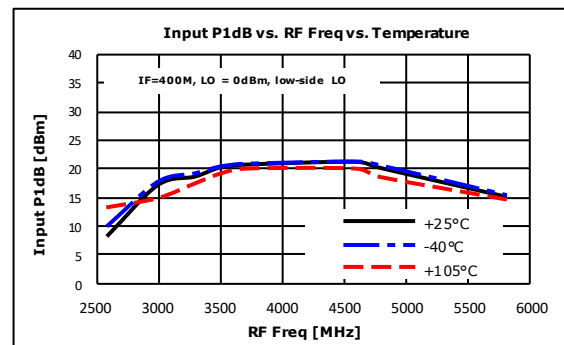
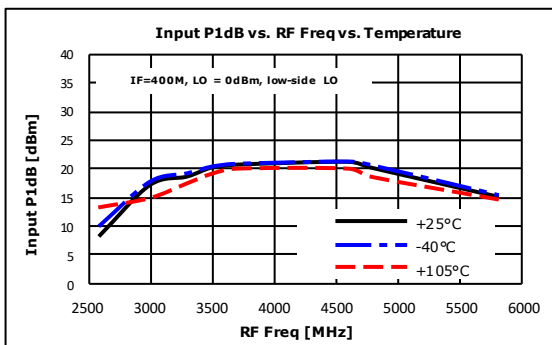
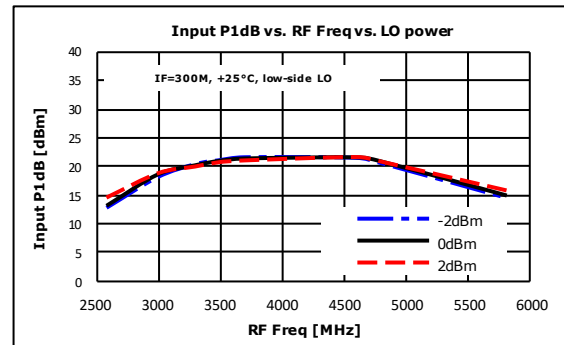
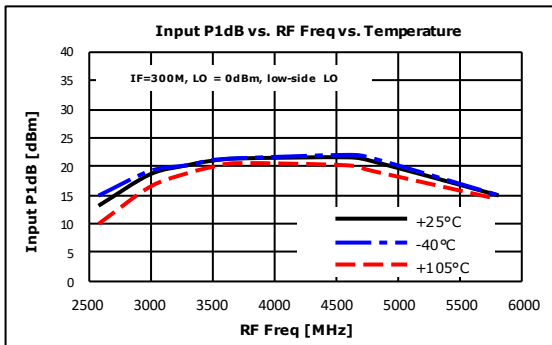
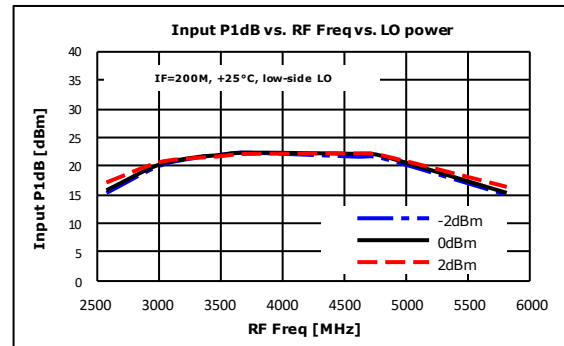
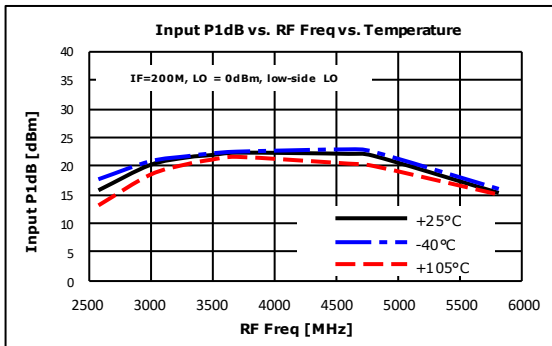
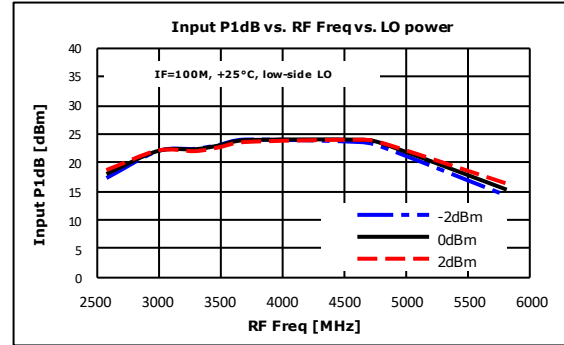
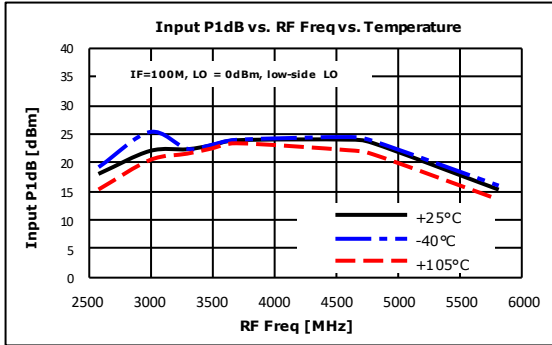
 Test condition : Measured on BeRex E/B at 25°C, 50ohm system, Vdd=5V, I<sub>ds</sub>=85mA , Up converting

Preliminary Datasheet

**Typical Test Data : 5V, IF to RF Converting**

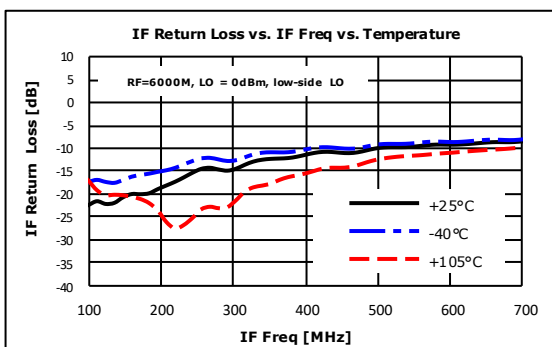
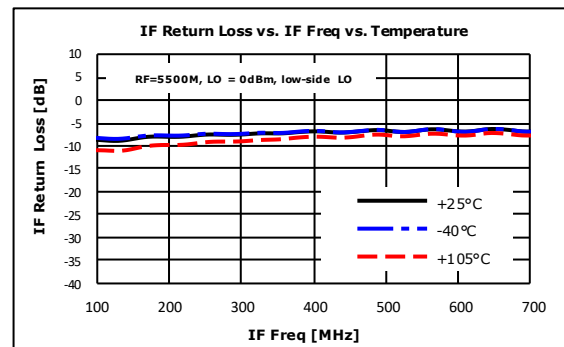
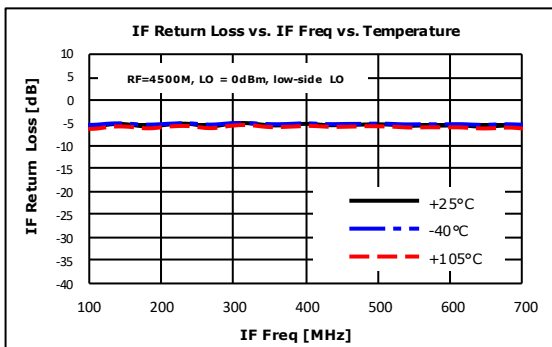
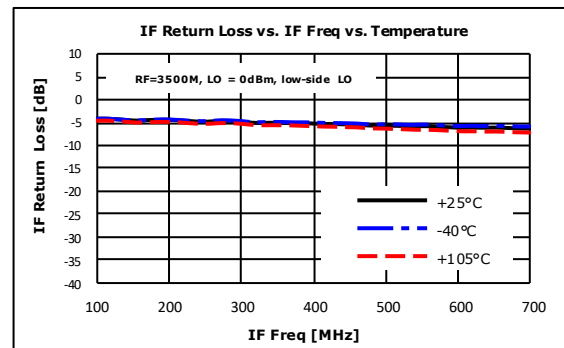
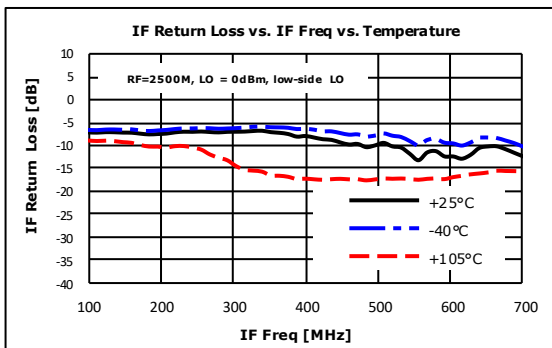
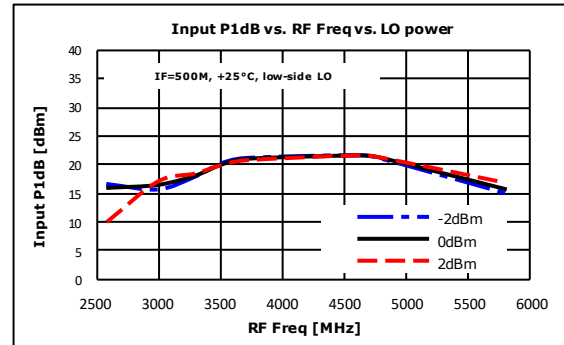
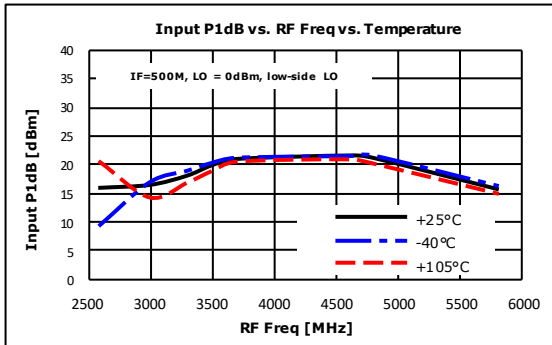
 Test condition : Measured on BeRex E/B at 25°C, 50ohm system, Vdd=5V, I<sub>ds</sub>=85mA , Up converting

Preliminary Datasheet

#### Typical Test Data : 3.3V, RF to IF Converting

Test condition : Measured on BeRex E/B at 25°C, 50ohm system, Vdd=3.3V, I<sub>ds</sub>=62mA , Down converting

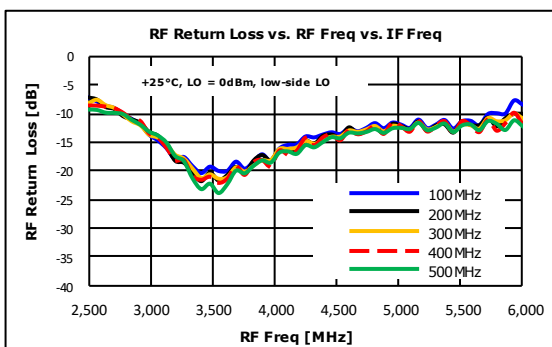
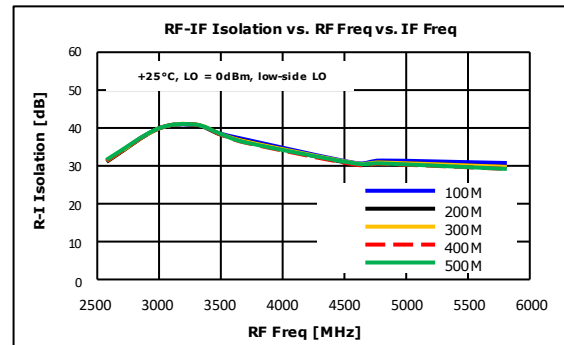
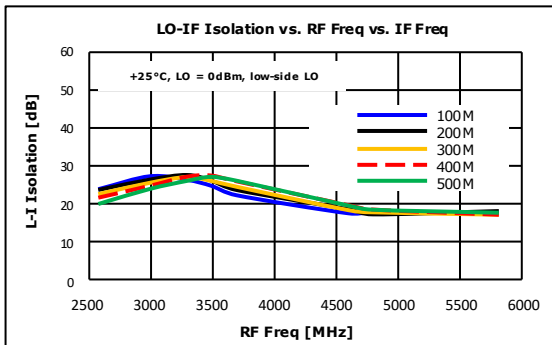
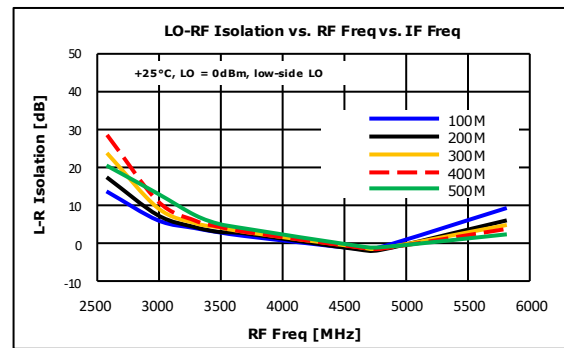
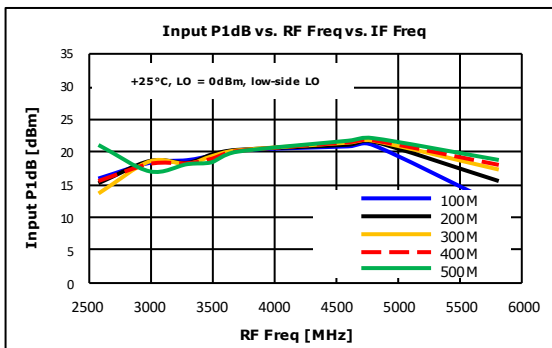
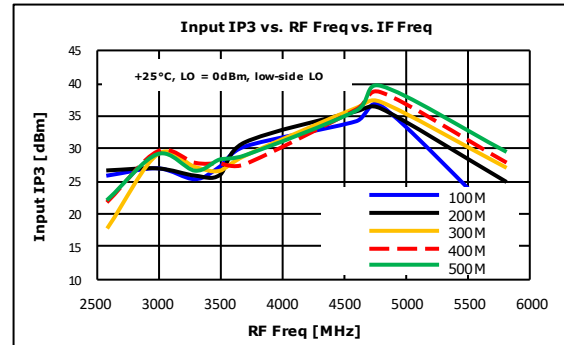
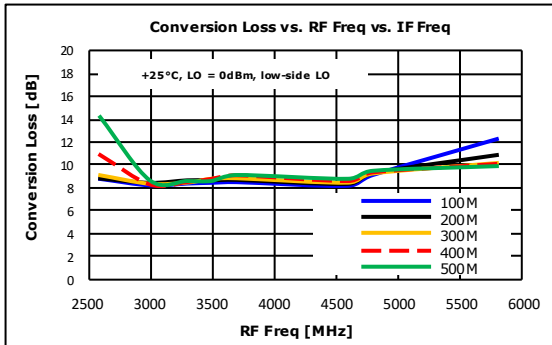

#### Typical Test Data : 3.3V, RF to IF Converting

Test condition : Measured on BeRex E/B at 25°C, 50ohm system, Vdd=3.3V, I<sub>ds</sub>=62mA , Down converting

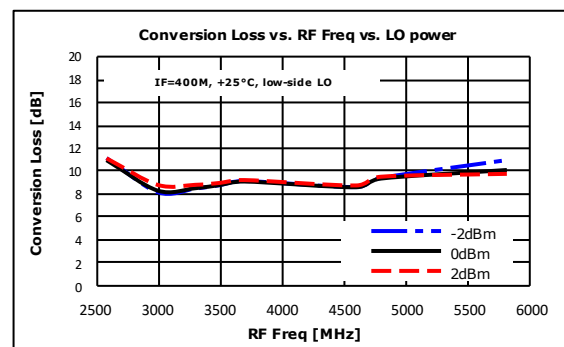
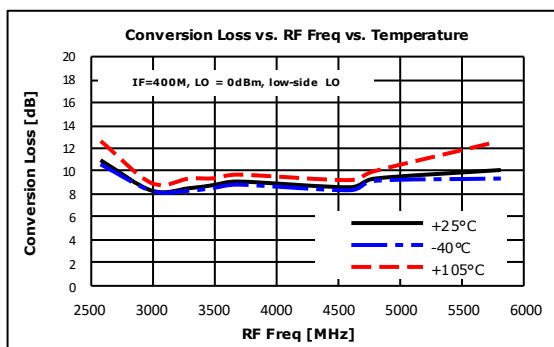
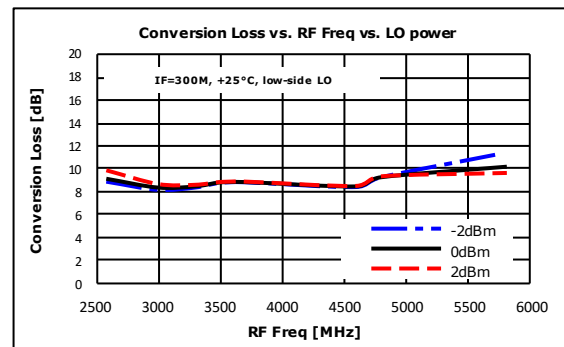
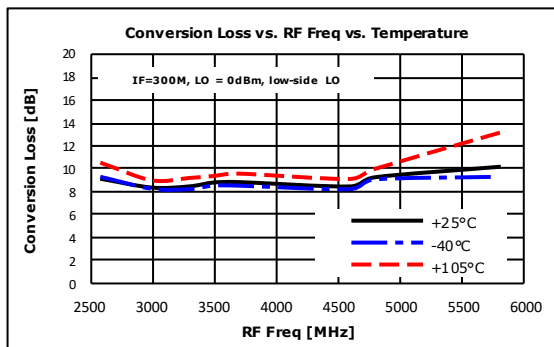
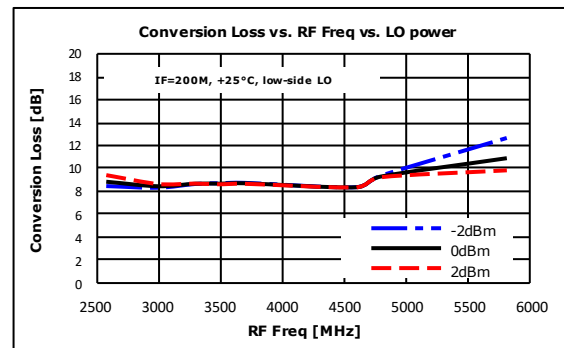
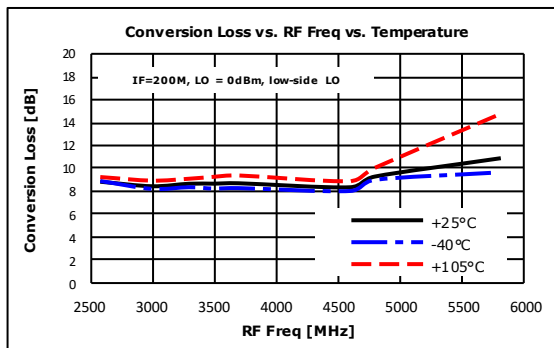
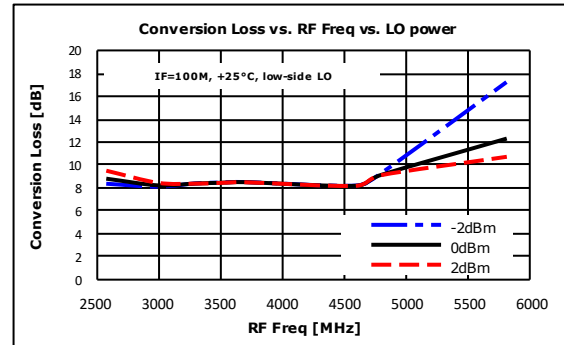
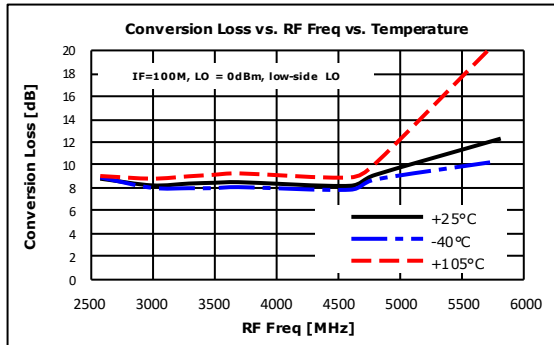

Preliminary Datasheet

#### Typical Test Data : 3.3V, RF to IF Converting

Test condition : Measured on BeRex E/B at 25°C, 50ohm system, Vdd=3.3V, I<sub>ds</sub>=62mA , Down converting

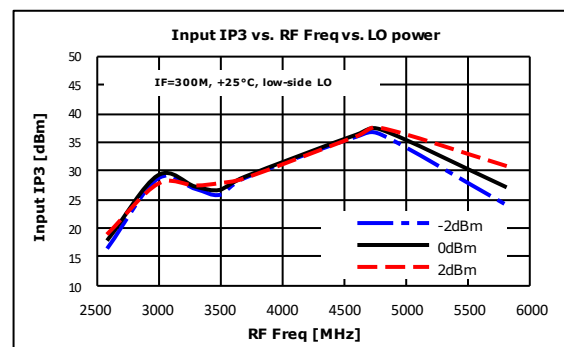
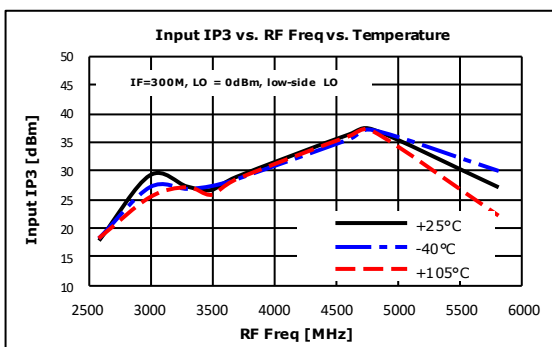
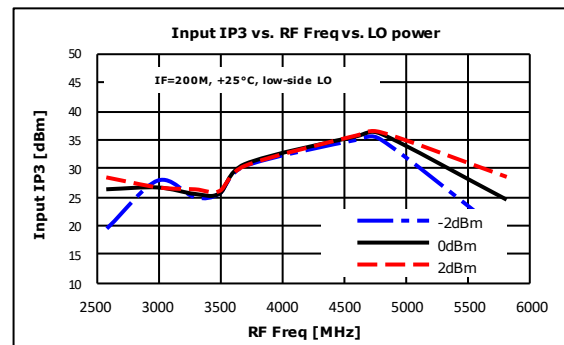
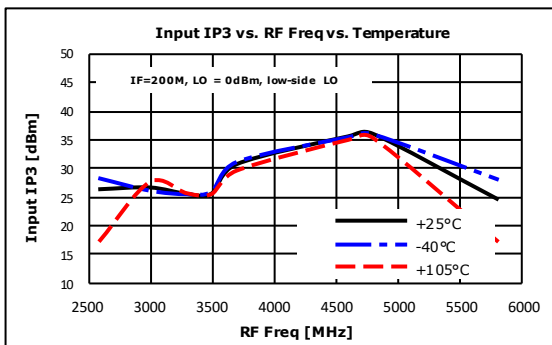
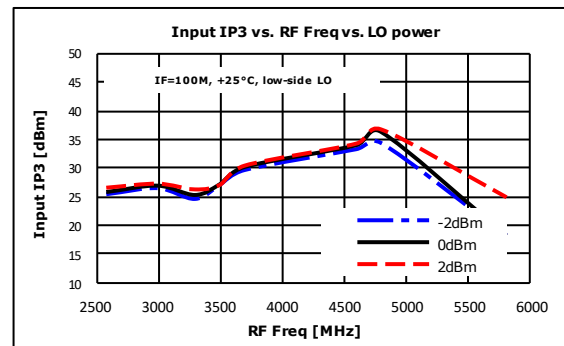
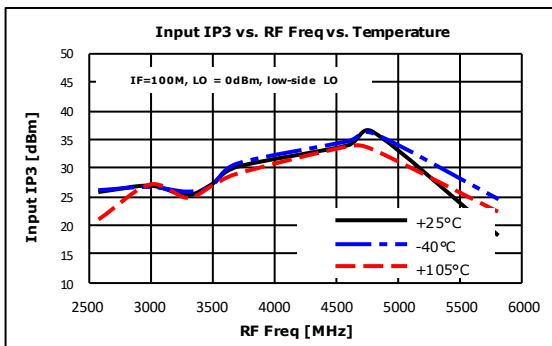
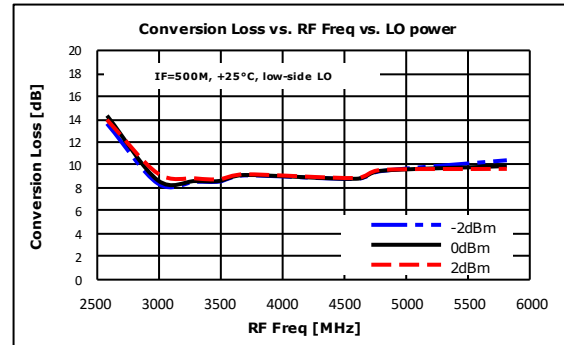
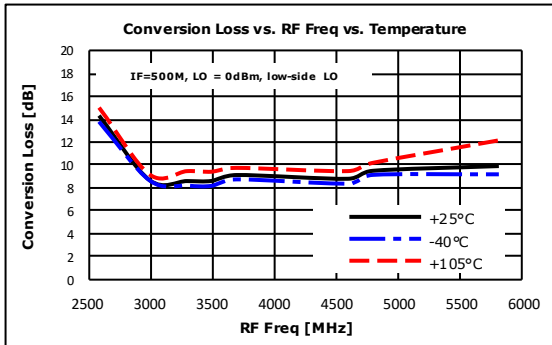

Preliminary Datasheet



#### Typical Test Data : 3.3V, RF to IF Converting

Test condition : Measured on BeRex E/B at 25°C, 50ohm system, Vdd=3.3V, I<sub>ds</sub>=62mA , Down converting

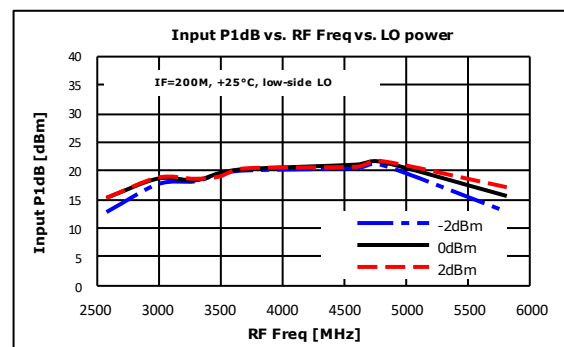
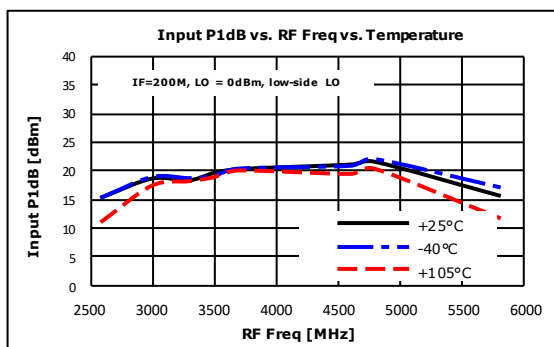
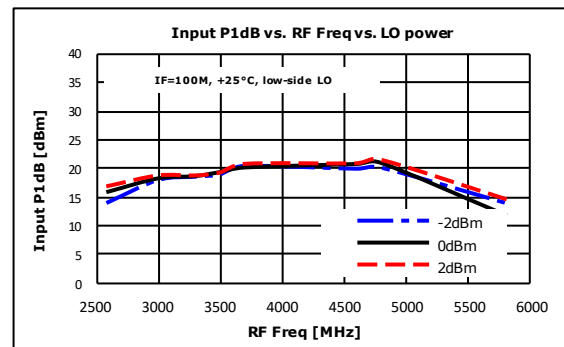
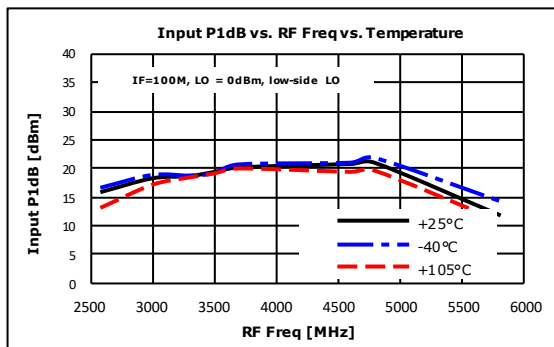
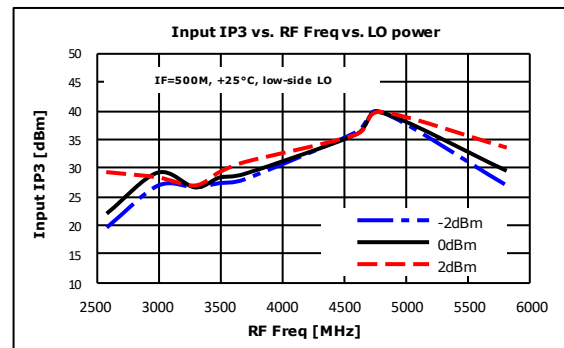
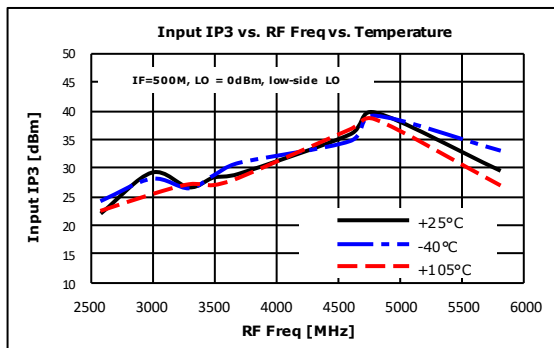
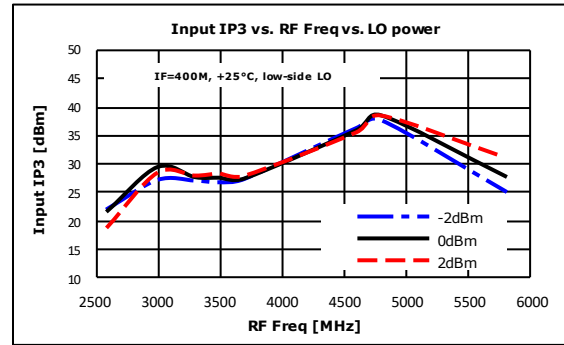
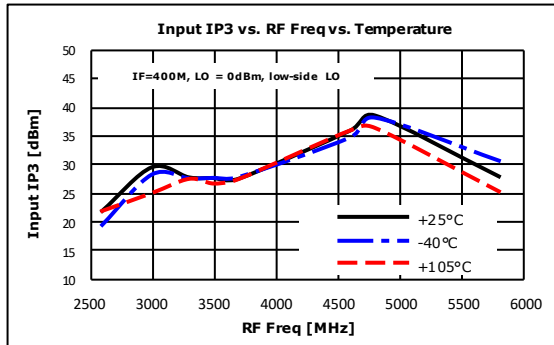

Preliminary Datasheet

#### Typical Test Data : 3.3V, RF to IF Converting

Test condition : Measured on BeRex E/B at 25°C, 50ohm system, Vdd=3.3V, I<sub>ds</sub>=62mA , Down converting

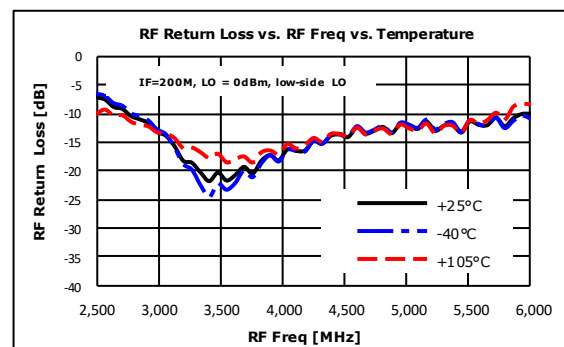
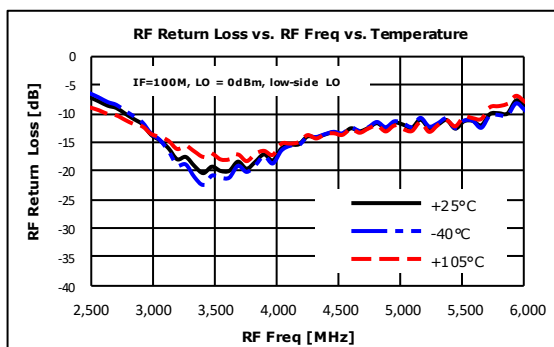
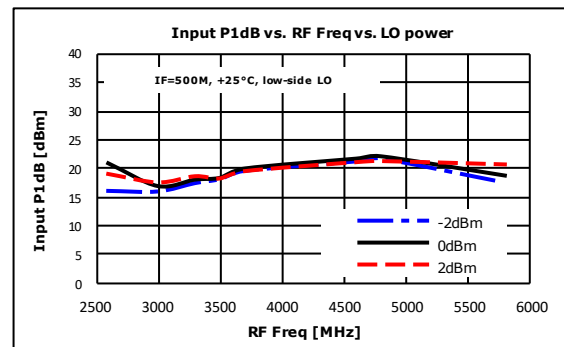
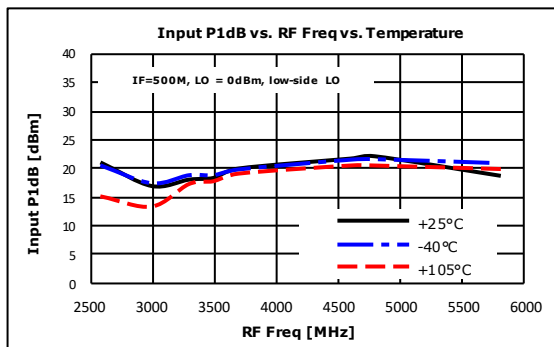
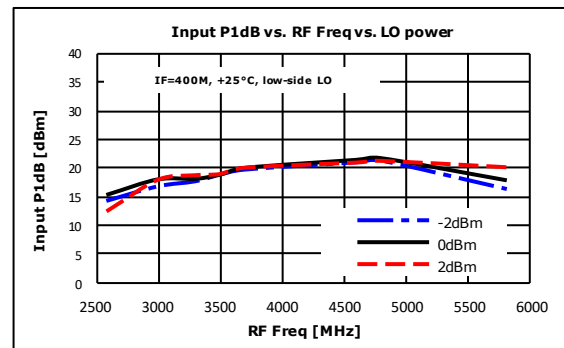
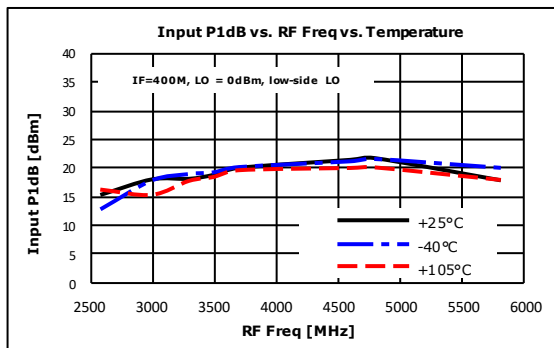
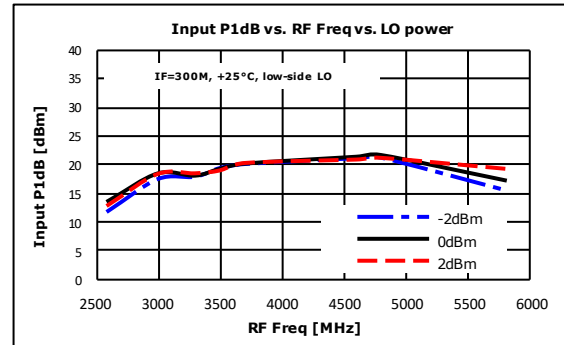
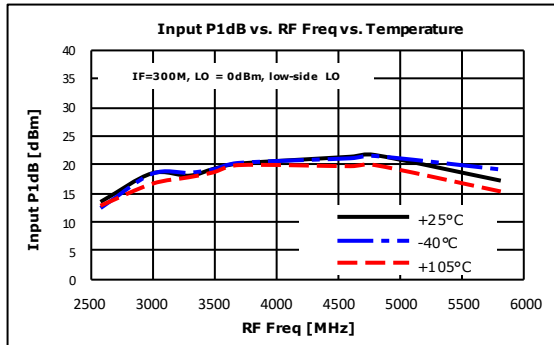

Preliminary Datasheet

**Typical Test Data : 3.3V, RF to IF Converting**

Test condition : Measured on BeRex E/B at 25°C, 50ohm system, Vdd=3.3V, Ids=62mA , Down converting

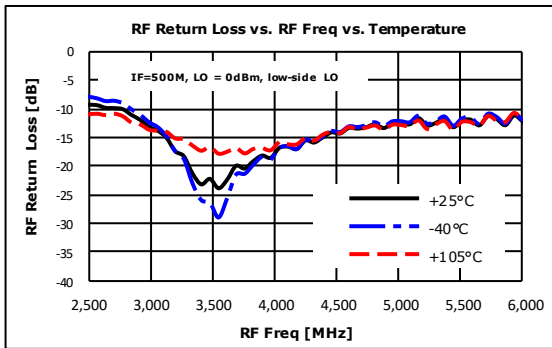
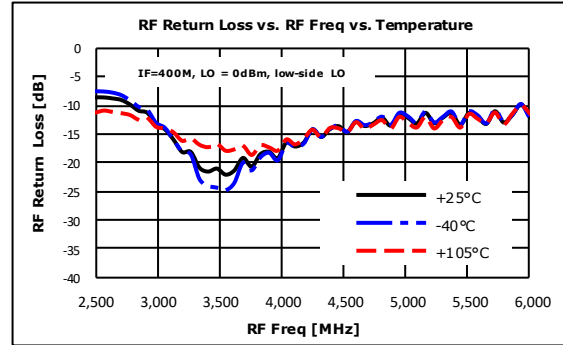
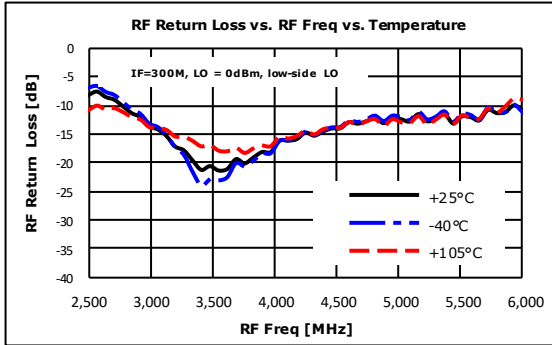

Preliminary Datasheet

#### Typical Test Data : 3.3V, IF to RF Converting

Test condition : Measured on BeRex E/B at 25°C, 50ohm system, Vdd=3.3V, I<sub>ds</sub>=62mA , Up converting

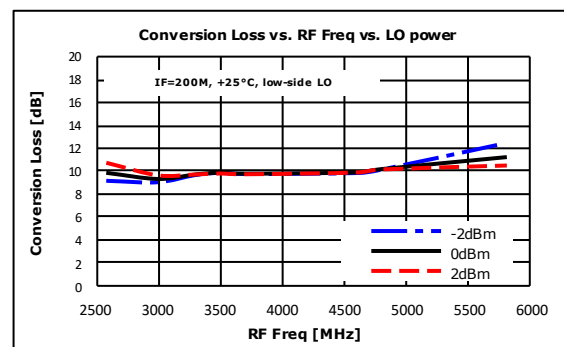
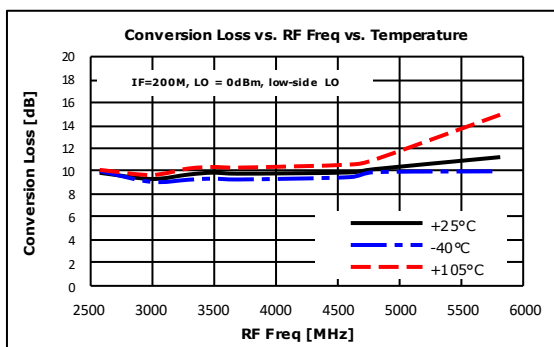
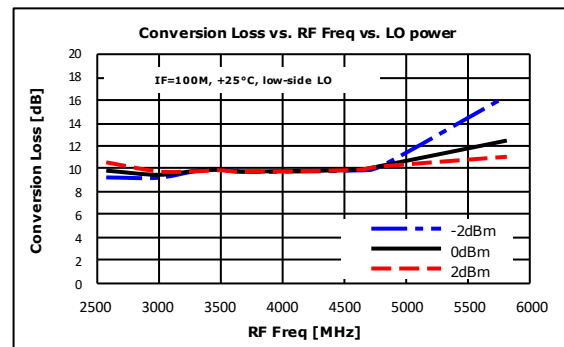
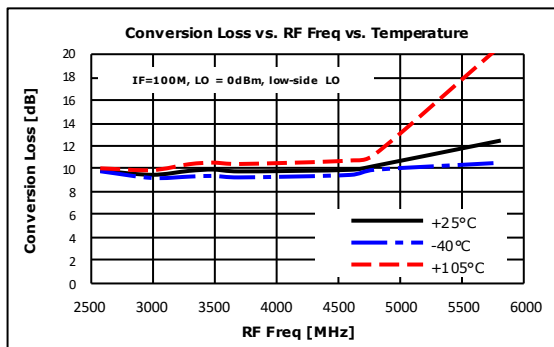
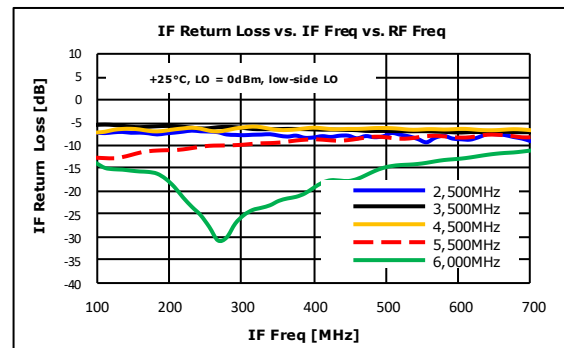
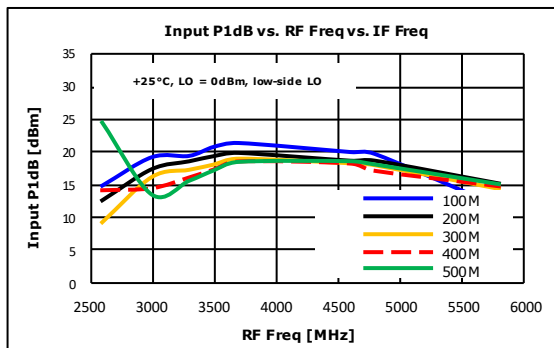
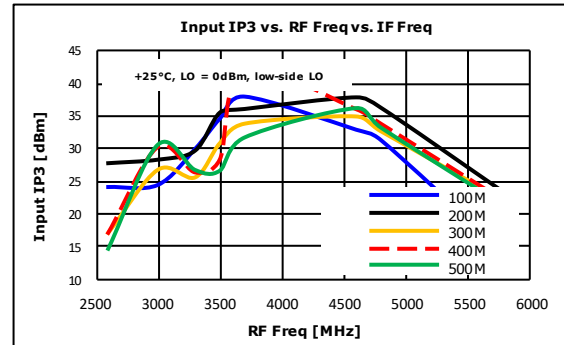
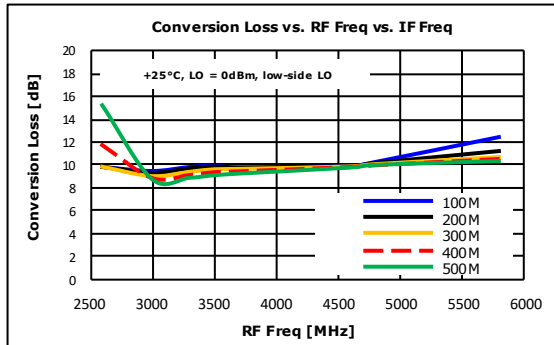

Preliminary Datasheet

#### Typical Test Data : 3.3V, IF to RF Converting

Test condition : Measured on BeRex E/B at 25°C, 50ohm system, Vdd=3.3V, I<sub>ds</sub>=62mA , Up converting

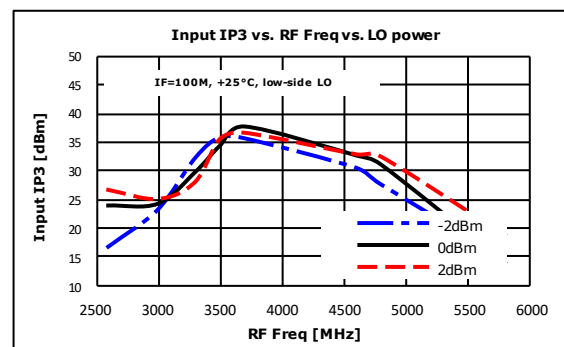
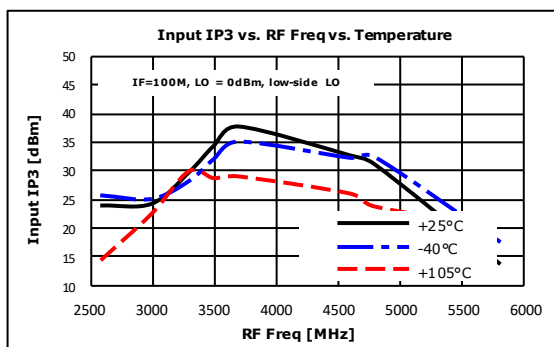
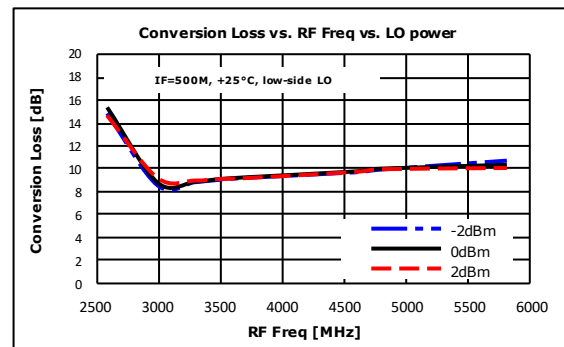
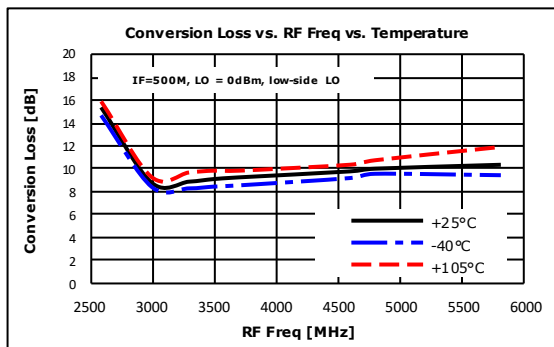
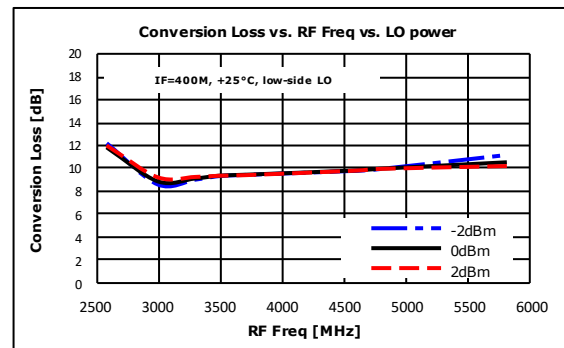
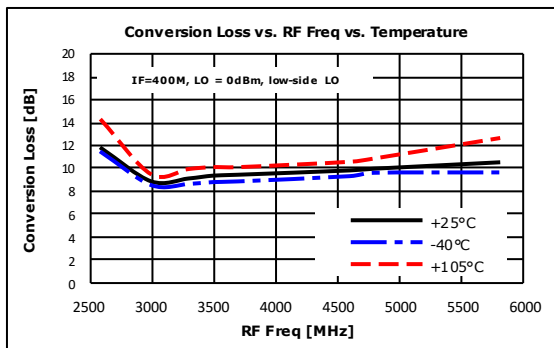
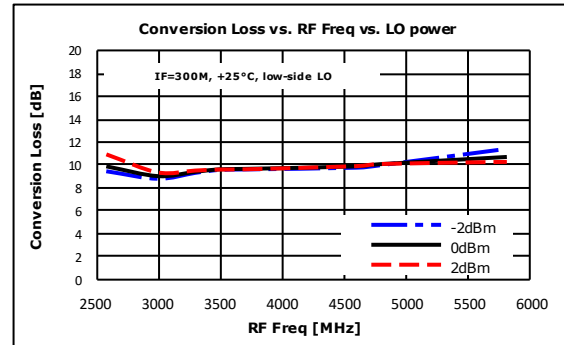
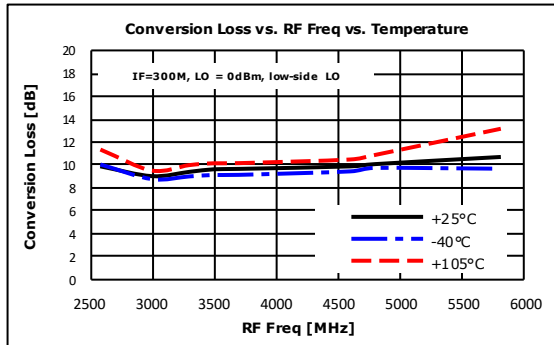

#### Typical Test Data : 3.3V, IF to RF Converting

Test condition : Measured on BeRex E/B at 25°C, 50ohm system, Vdd=3.3V, I<sub>ds</sub>=62mA , Up converting

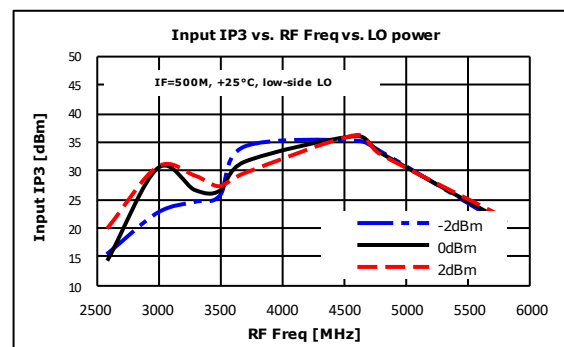
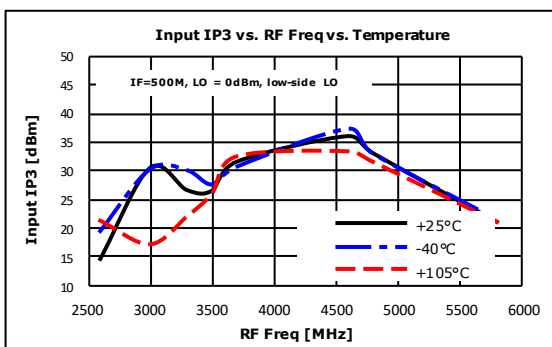
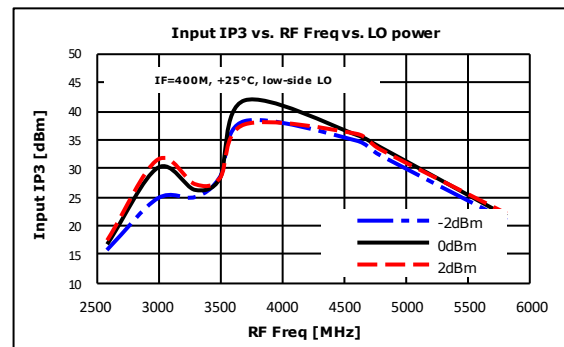
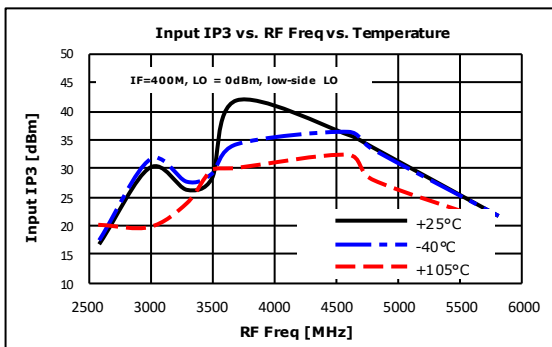
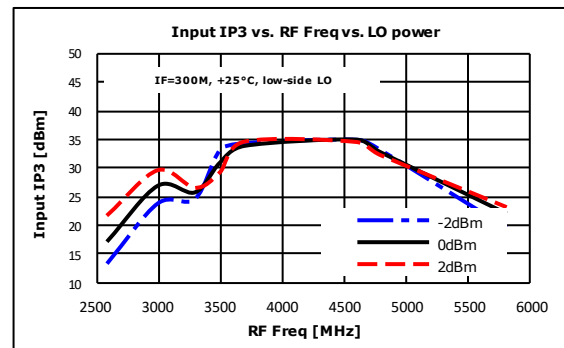
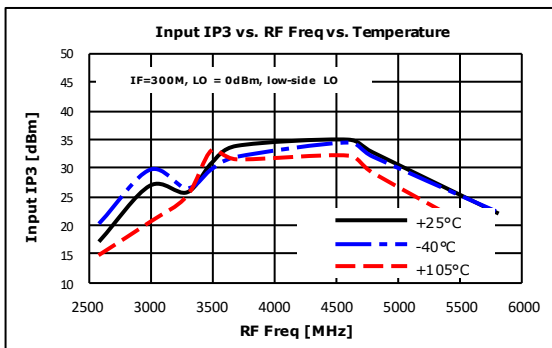
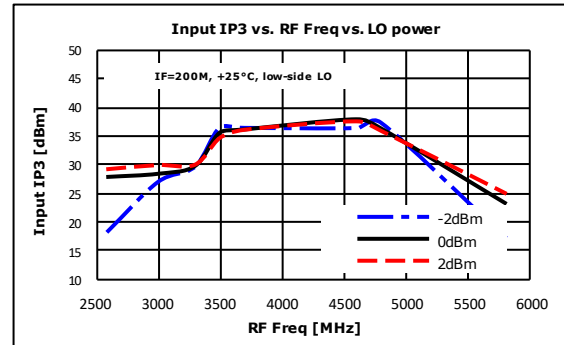
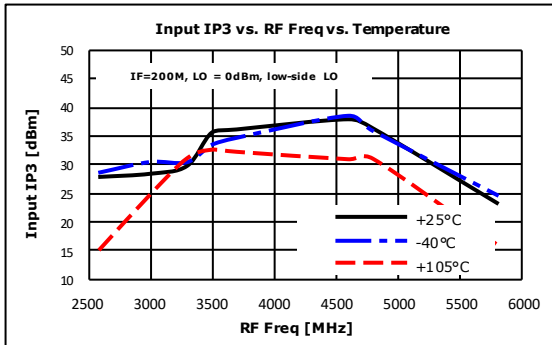

Preliminary Datasheet

#### Typical Test Data : 3.3V, IF to RF Converting

Test condition : Measured on BeRex E/B at 25°C, 50ohm system, Vdd=3.3V, I<sub>ds</sub>=62mA , Up converting

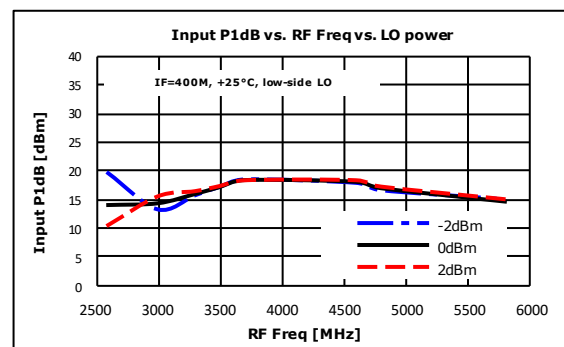
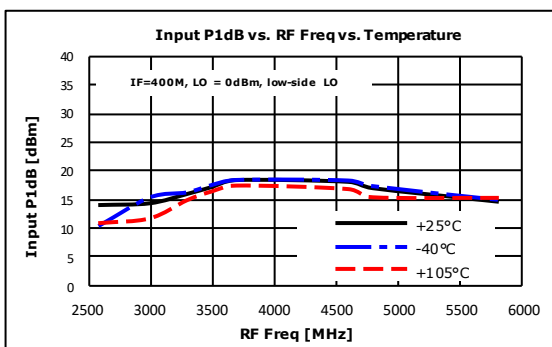
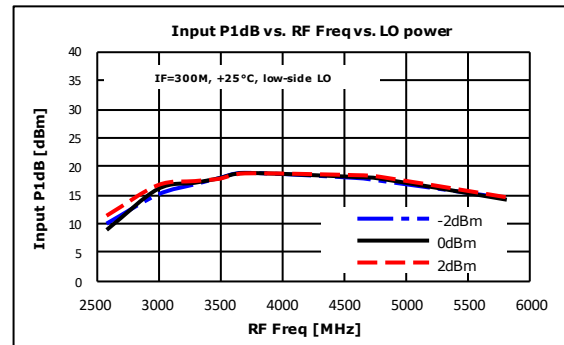
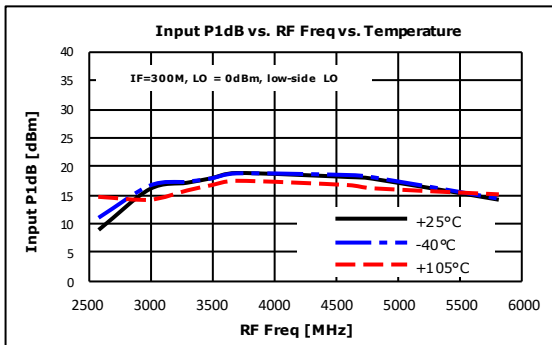
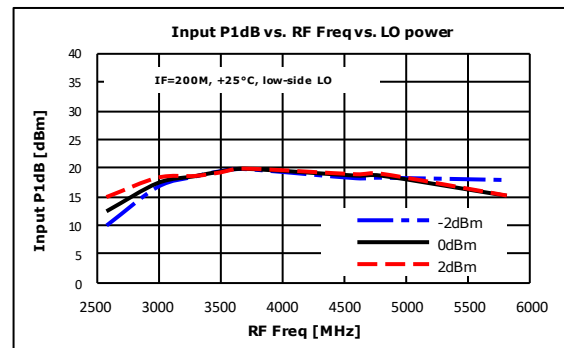
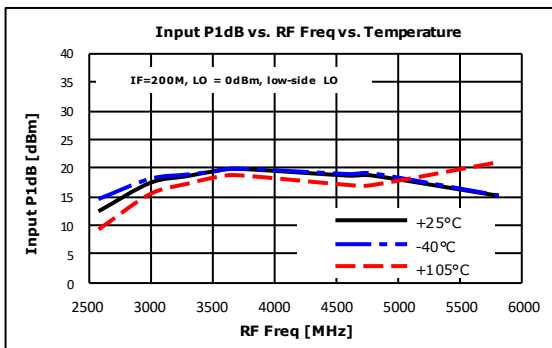
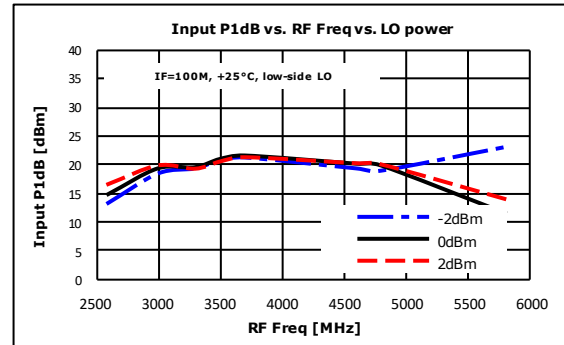
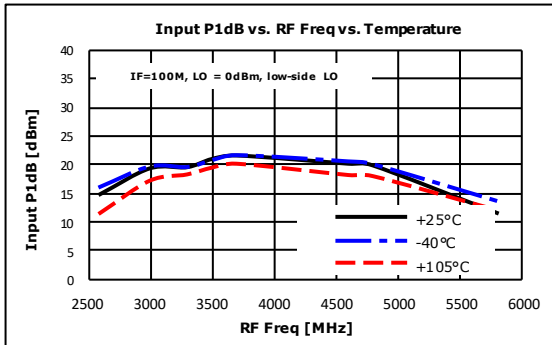

Preliminary Datasheet

**Typical Test Data : 3.3V, IF to RF Converting**

Test condition : Measured on BeRex E/B at 25°C, 50ohm system, Vdd=3.3V, Ids=62mA , Up converting

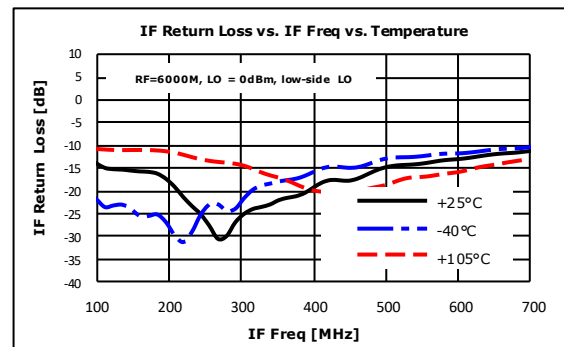
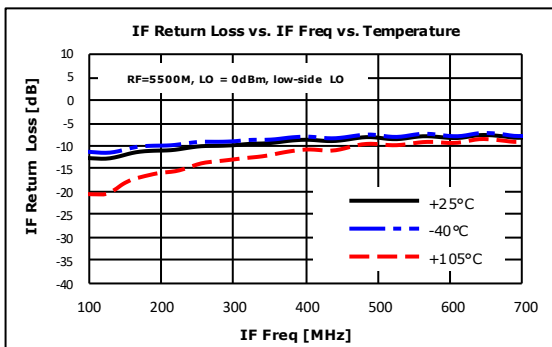
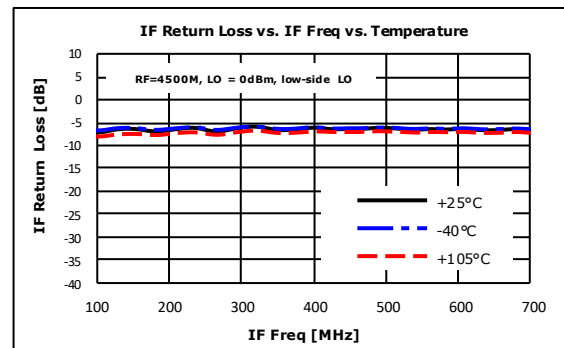
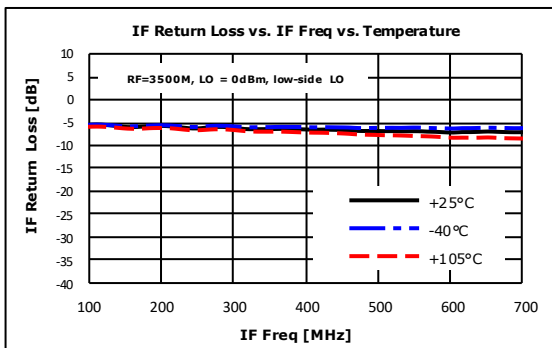
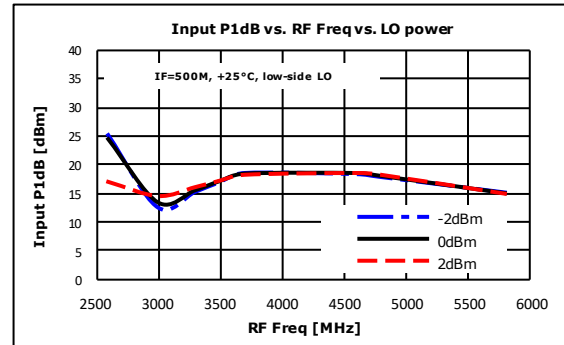
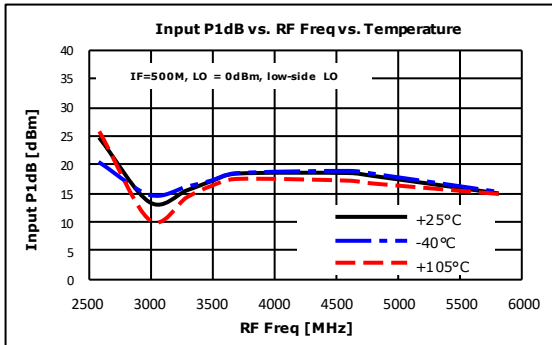

Preliminary Datasheet



### Package Outline Drawing

A ORIGINAL ISSUE OCT13,B014

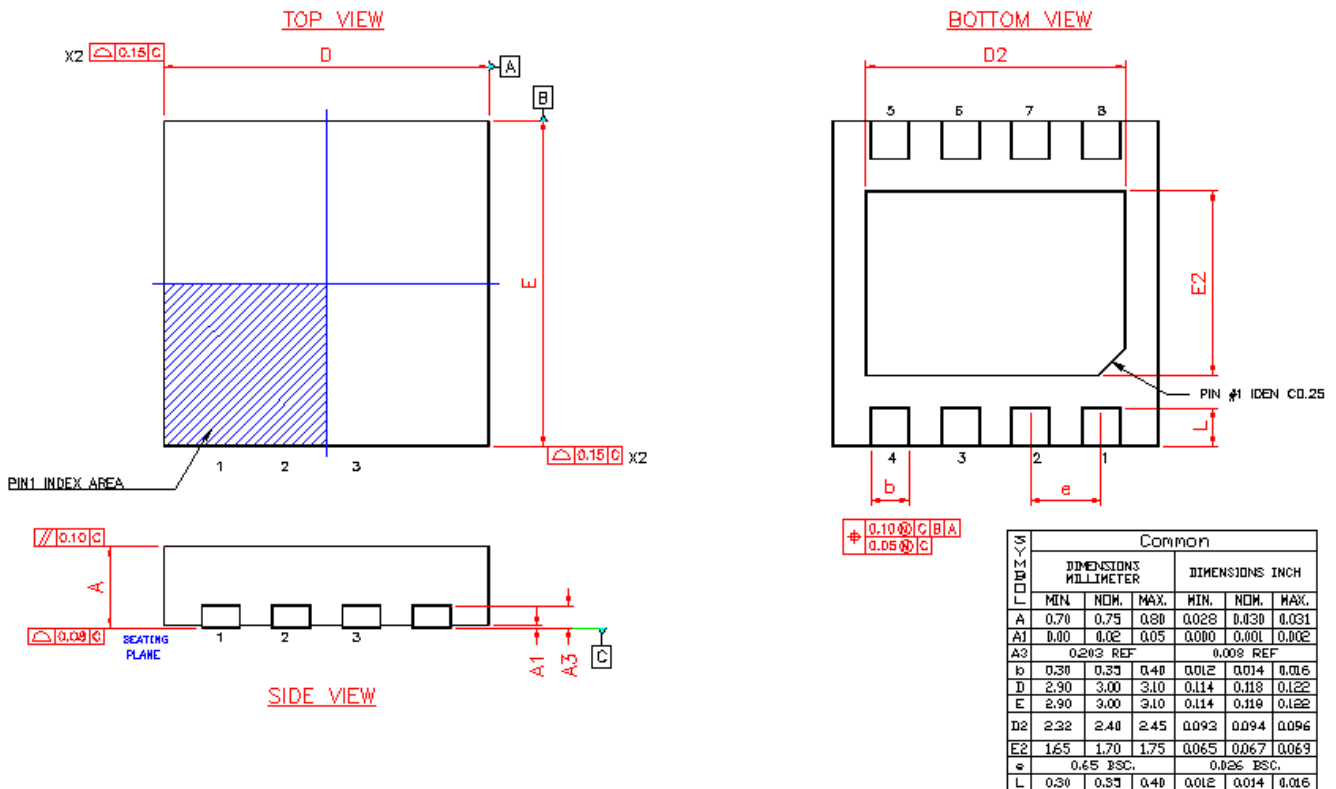

### Package Marking

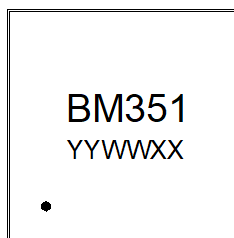

YY = Year, WW = Working Week,  
XX = Wafer No.

### Evaluation Board Drawing

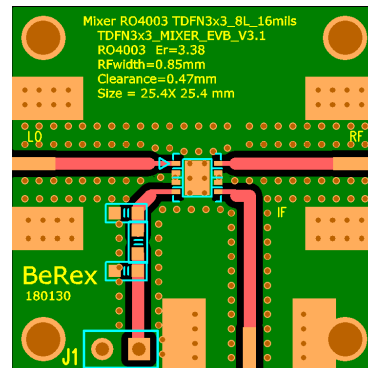

Preliminary Datasheet

## Suggested PCB Land Pattern and PAD Layout

### PCB Land Pattern

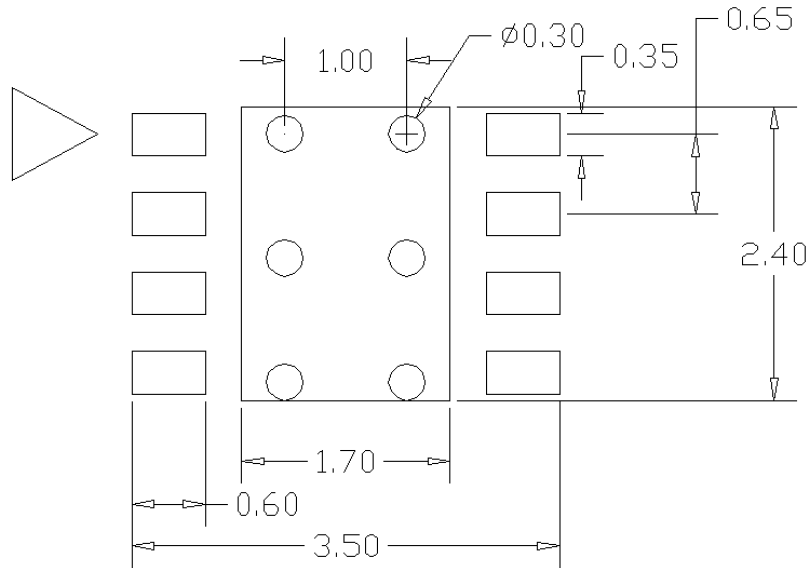

**Note :** 1. Connection to Bottom Ground with multiple via holes.

2. Via holes \_ as many as possible.
3. All Dimensions \_ millimeters.
4. PCB lay out \_ on BeRex website.

### Pin Configuration

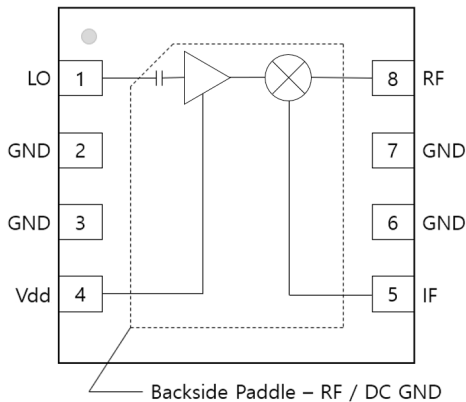

Pin No.	Label	Description
1	LO	Local Oscillator Injection. Internally DC Blocked
2,3,6,7	GND	RF/DC Ground.
4	Vdd	Power supply for LO amplifier
5	IF	Intermediate Frequency
8	RF	Radio Frequency
Backside Paddle	GND	RF/DC Ground. Follow recommended via pattern and ensure good solder attach for best thermal and electrical performance.

### Tape & Reel

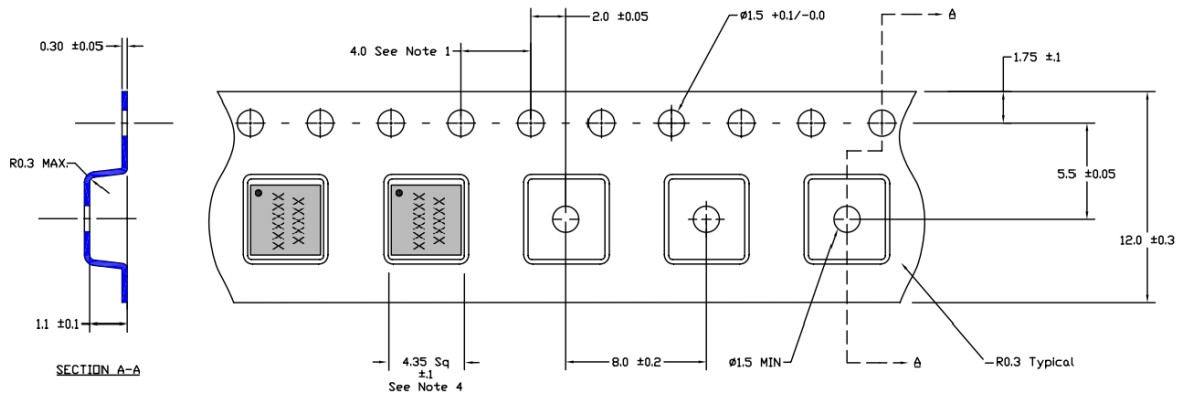

Packaging information:	
Tape Width	12mm
Reel Size	7"
Device Cavity Pitch	8mm
Devices Per Reel	1K

### Lead plating finish

#### 100% Tin Matte finish

(All BeRex products undergoes a 1 hour, 150 degree C, Anneal bake to eliminate thin whisker growth concerns.)

### MSL / ESD Rating

<b>ESD Rating:</b>	Class 1A
<b>Value:</b>	Passes <500V
<b>Test:</b>	Human Body Model (HBM)
<b>Standard:</b>	JEDEC Standard JESD22-A114B
<b>MSL Rating:</b>	Level 1 at +265°C convection reflow
<b>Standard:</b>	JEDEC Standard J-STD-020



Proper ESD procedures should be followed when handling this device.

### NATO CAGE code:

2	N	9	6	F
---	---	---	---	---