

1500 -3000 MHz Wideband High Linearity LNA Gain Block

Device Features

- Internally matched to 50 ohms
- This can be operated at Vd of 3.3V and 4.4V
- 37.0 dBm Output IP3 at 5dBm/tone at 1900MHz
- 15.5 dB Gain at 1900 MHz
- 22.0 dBm P1dB at 1900 MHz
- 1.6 dB NF at 1.9GHz
- Green/RoHS2 Compliant SOT89 SMT Package



Product Description

BeRex's BNT01 is a wideband high linearity LNA gain block, based on GaAs material with E-pHEMT process and packaged in a RoHS2-compliant with SOT-89 Surface mount package. It is designed for use where low noise and high linearity are required and features low noise and high OIP3 at wideband frequency. It is internally matched to 50 Ohms without the need for external matching components. All devices are 100% RF/DC tested and classified as HBM ESD Class 1A.

Applications

- Base station Infrastructure/RFID
- Commercial/Industrial/Military wireless system

Applications Circuit

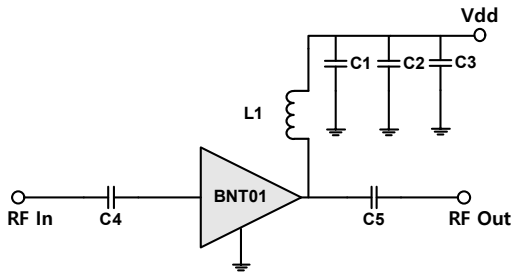

BOM	Value	Size	Tolerance
C1	100pF	0603	5%
C2	1000pF	0603	5%
C3	10uF	1206	10%
C4	9pF	0603	±0.25pF
C5	43pF	0603	5%
L1	39nH	0603	5%

Electrical Specifications

Device performance _ measured on a BeRex evaluation board at 25°C, Vd=4.4V, 50 Ω system.

Parameter	Conditions	Min	Typ	Max	Unit
Operational Frequency Range		1500		3000	MHz
Test Frequency			1900		MHz
Gain		14.0	15.5		dB
Input Return Loss			-16.5		dB
Output Return Loss			-20.0		dB
Output IP3	5 dBm / tone , Δf=1 MHz	34.0	37.0		dBm
Output P1dB		21.0	22.0		dBm
Noise Figure			1.6	1.8	dB

* Noise Figure data has input trace loss de-embedded.

Device performance _ measured on a BeRex evaluation board at 25°C, Vd=3.3V, 50 Ω system.

Parameter	Conditions	Min	Typ	Max	Unit
Operational Frequency Range		1500		3000	MHz
Test Frequency			1900		MHz
Gain		13.5	15.0		dB
Input Return Loss			-16.5		dB
Output Return Loss			-21.0		dB
Output IP3	5 dBm / tone , Δf=1 MHz	32.5	35.5		dBm
Output P1dB		18.5	19.5		dBm
Noise Figure			1.6	1.8	dB

* Noise Figure data has input trace loss de-embedded.

Recommended Operating Conditions

Parameter	Min	Typ	Max	Unit
Bandwidth	1500		3000	MHz
I _d @ (V _d = 4.4V)	50	68	82	mA
I _d @ (V _d = 3.3V)	38	47	56	mA
V _d	3.3	4.4	4.6	V
dG/dT		-0.003		dB/°C
R _{TH}		95		°C/W
Operating Case Temperature	-40		+85	°C

Electrical specifications are measured at specified test conditions.

Specifications are not guaranteed over all recommended operating conditions.

1500 -3000 MHz Wideband High Linearity LNA Gain Block

Absolute Maximum Ratings

Parameter	Rating	Unit
Storage Temperature	-55 to +155	°C
Junction Temperature	+180	°C
Supply Voltage	+6	V
Supply Current	130	mA
Input RF Power	23	dBm

Operation of this device above any of these parameters may result in permanent damage.

Typical Performance (V_d=4.4V, I_d=68mA , T=25°C)

Parameter	Frequency			Unit
V _d = 4.4V	1900	2140	2650	MHz
Gain	15.5	14.5	13.0	dB
S11	-16.5	-17.0	-19.5	dB
S22	-20.0	-18.5	-13.0	dB
OIP3	37.0	37.0	36.0	dBm
P1dB	22.0	22.0	22.0	dBm
Noise Figure	1.6	1.7	1.8	dB

Typical Performance (V_d=3.3V, I_d=47mA , T=25°C)

Parameter	Frequency			Unit
V _d = 3.3V	1900	2140	2650	MHz
Gain	15.0	14.0	12.5	dB
S11	-16.5	-16.5	-18.0	dB
S22	-21.0	-19.5	-13.5	dB
OIP3	35.5	36.0	35.0	dBm
P1dB	19.5	20.0	20.0	dBm
Noise Figure	1.6	1.6	1.7	dB

* Noise Figure data has input trace loss de-embedded.

V-I Characteristics

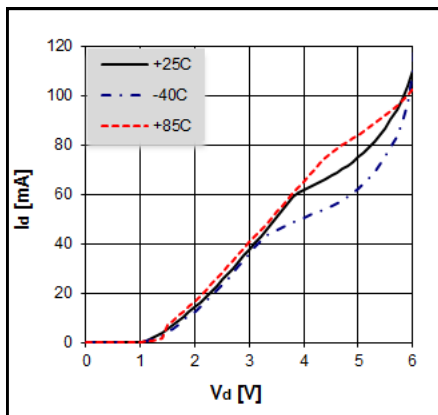

BeRex SOT89 Evaluation Board

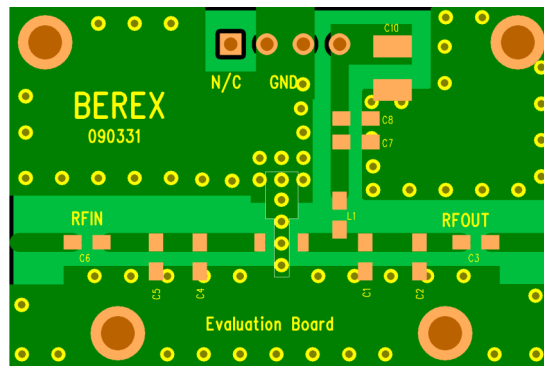

*Dielectric constant _ 4.2 *RF pattern width 52mil *31mil thick FR4 PCB

1500 -3000 MHz Wideband High Linearity LNA Gain Block

Typical Device Data

S-parameters ($V_d=4.4V$, $I_d=68mA$, $T=25^\circ C$)

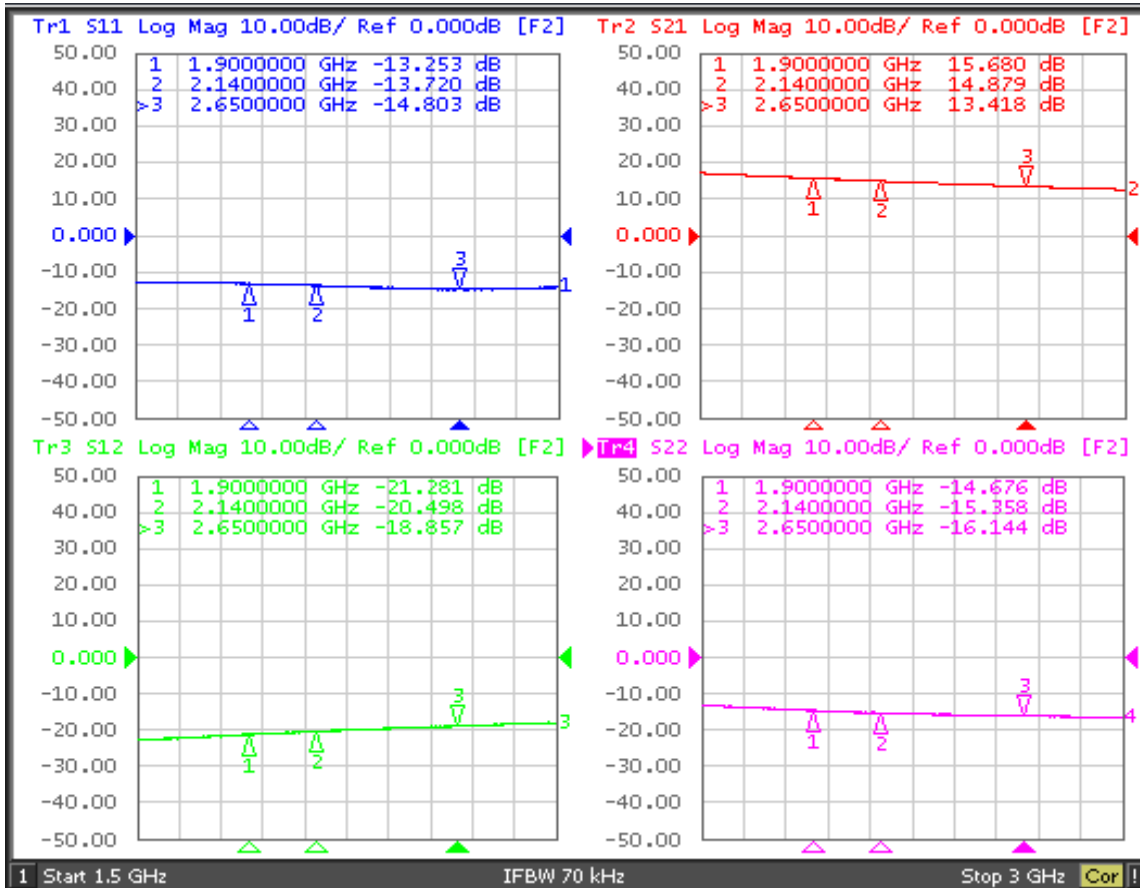

S-Parameter

($V_d=4.4V$, $I_d = 68mA$, $T = 25^\circ C$, calibrated to device leads)

Freq [MHz]	S11	S11	S21	S21	S12	S12	S22	S22
	Mag	Ang	Mag	Ang	Mag	Ang	Mag	Ang
1500	0.21	155.96	7.19	90.39	0.07	28.60	0.22	73.75
2000	0.23	145.09	5.83	72.67	0.09	26.29	0.18	59.00
2500	0.23	133.56	4.90	57.27	0.11	20.75	0.14	40.48
3000	0.23	118.22	4.22	42.87	0.13	14.03	0.11	23.19
3500	0.26	102.19	3.71	29.21	0.15	6.66	0.11	16.14
4000	0.30	88.92	3.34	15.62	0.16	-1.45	0.11	23.35

1500 -3000 MHz Wideband High Linearity LNA Gain Block

Typical Device Data

S-parameters ($V_d=3.3V$, $I_d=47mA$, $T=25^\circ C$)

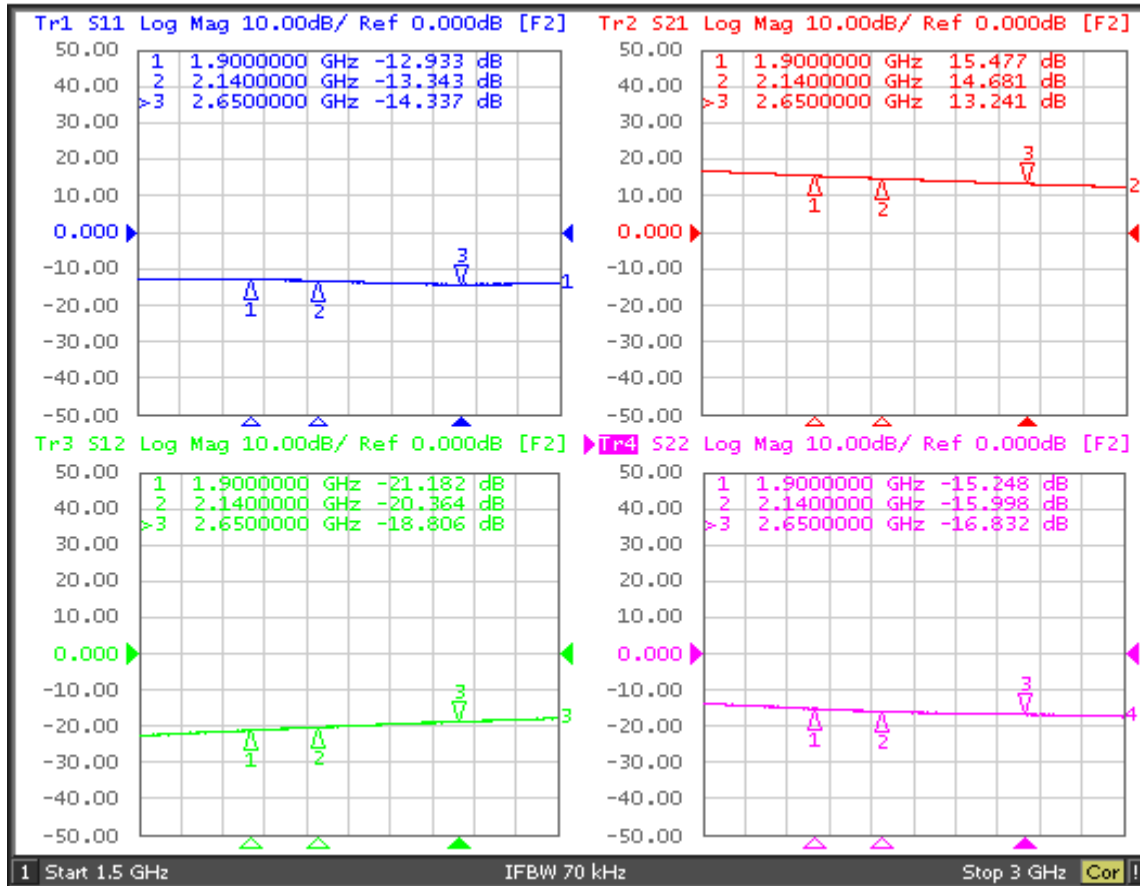

S-Parameter

($V_d=3.3V$, $I_d = 47mA$, $T = 25^\circ C$, calibrated to device leads)

Freq [MHz]	S11 Mag	S11 Ang	S21 Mag	S21 Ang	S12 Mag	S12 Ang	S22 Mag	S22 Ang
1500	0.21	162.00	7.01	91.01	0.07	27.71	0.20	76.38
2000	0.24	148.94	5.70	73.25	0.09	26.75	0.17	63.05
2500	0.24	136.58	4.79	57.65	0.11	21.42	0.13	45.92
3000	0.24	121.21	4.14	43.10	0.13	13.96	0.11	29.25
3500	0.27	104.45	3.65	29.40	0.15	6.26	0.10	23.24
4000	0.30	90.91	3.28	15.83	0.17	-1.81	0.11	31.06

1500 -3000 MHz Wideband High Linearity LNA Gain Block

WCDMA 4FA 2140MHz -50dBc (Vd=4.4V)

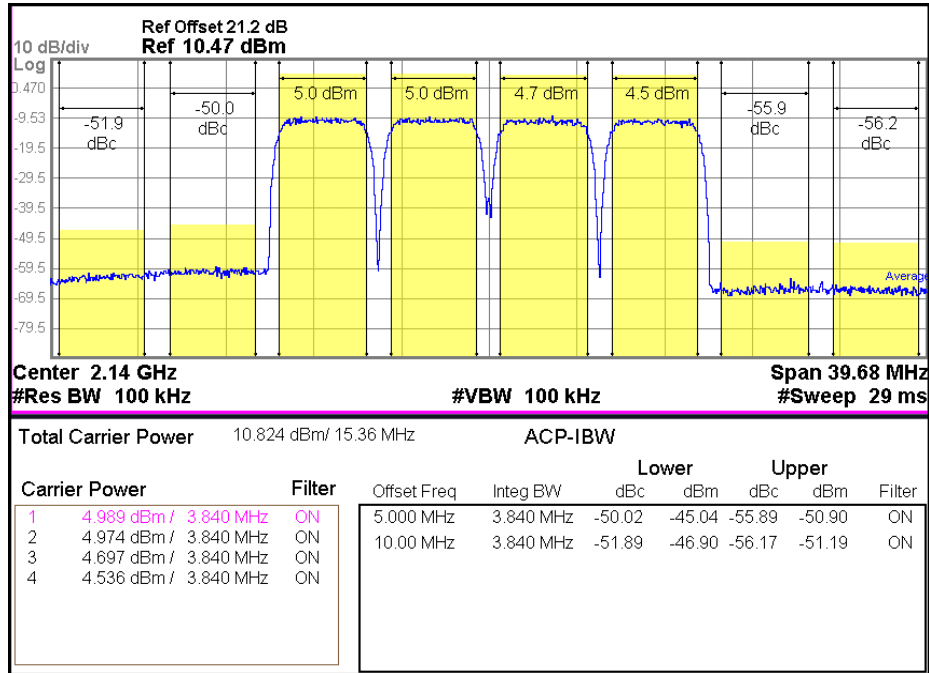

WCDMA 4FA 2140MHz -50dBc (Vd=3.3V)

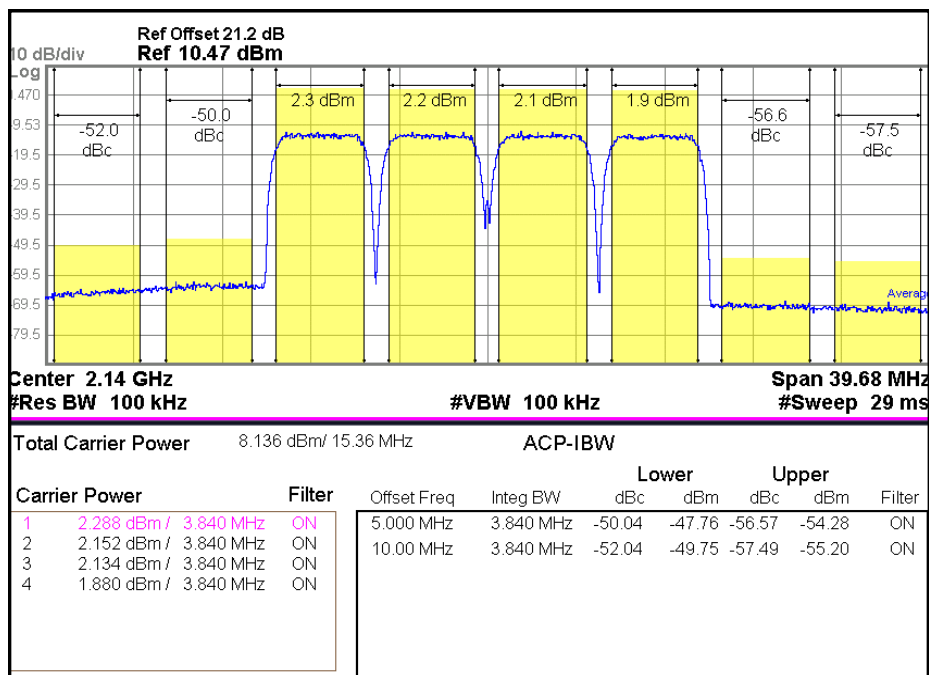

1500 -3000 MHz Wideband High Linearity LNA Gain Block

WCDMA 6FA 2140MHz -50dBc (Vd=4.4V)

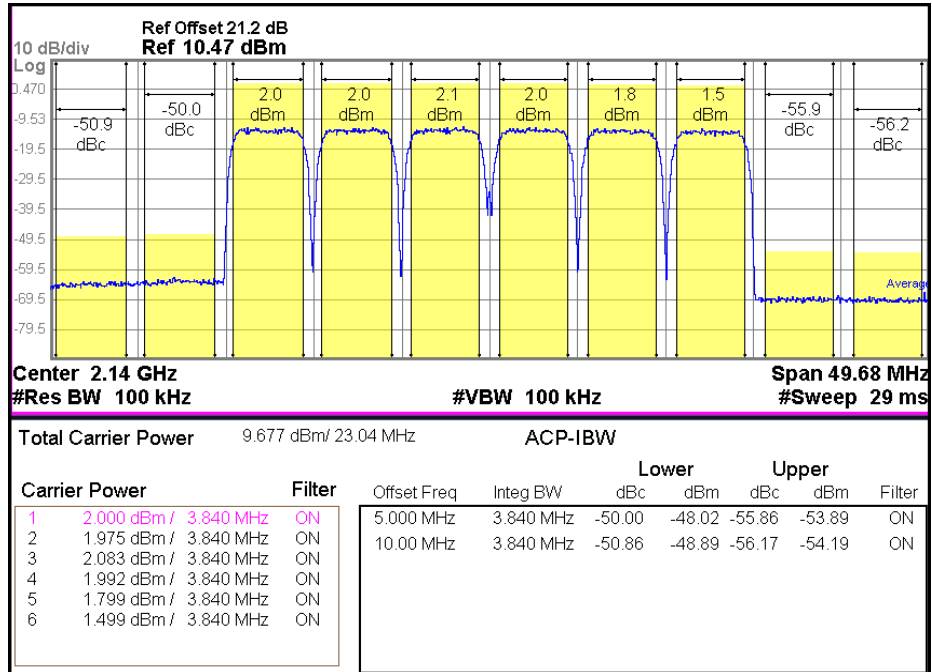

WCDMA 6FA 2140MHz -50dBc (Vd=3.3V)

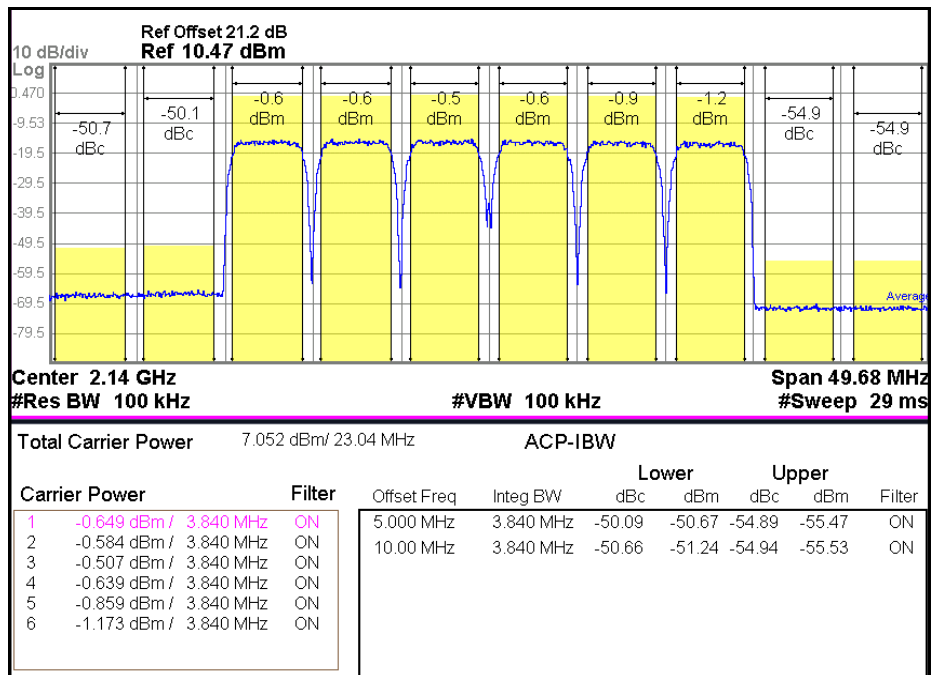

1500 -3000 MHz Wideband High Linearity LNA Gain Block

LTE TM3p1 100% 20MHz 1850MHz -50dBc (Vd=4.4V)

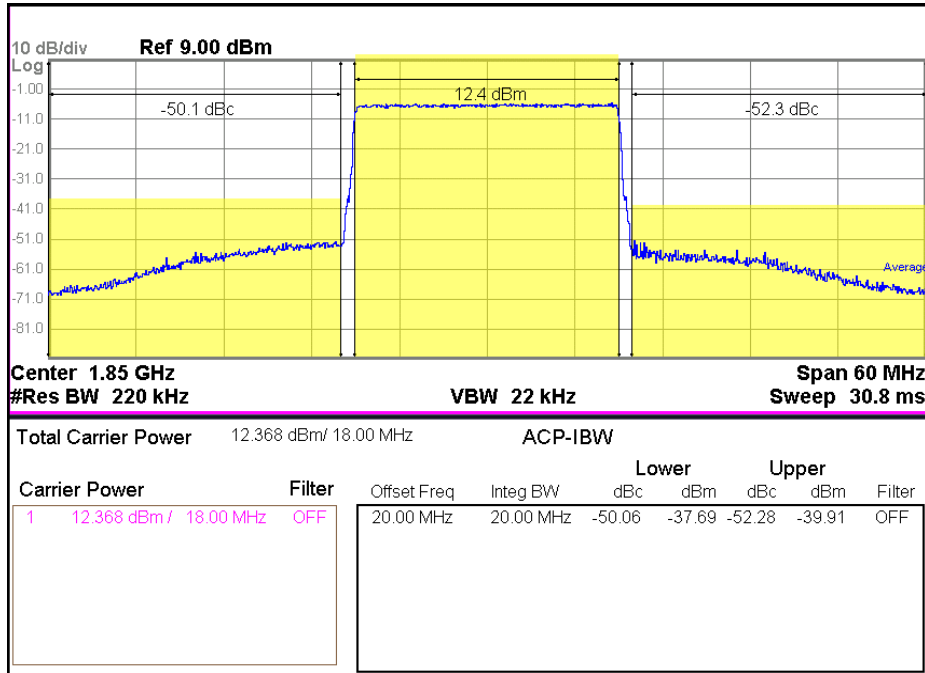

LTE TM3p1 100% 20MHz 1850MHz -50dBc (Vd=3.3V)

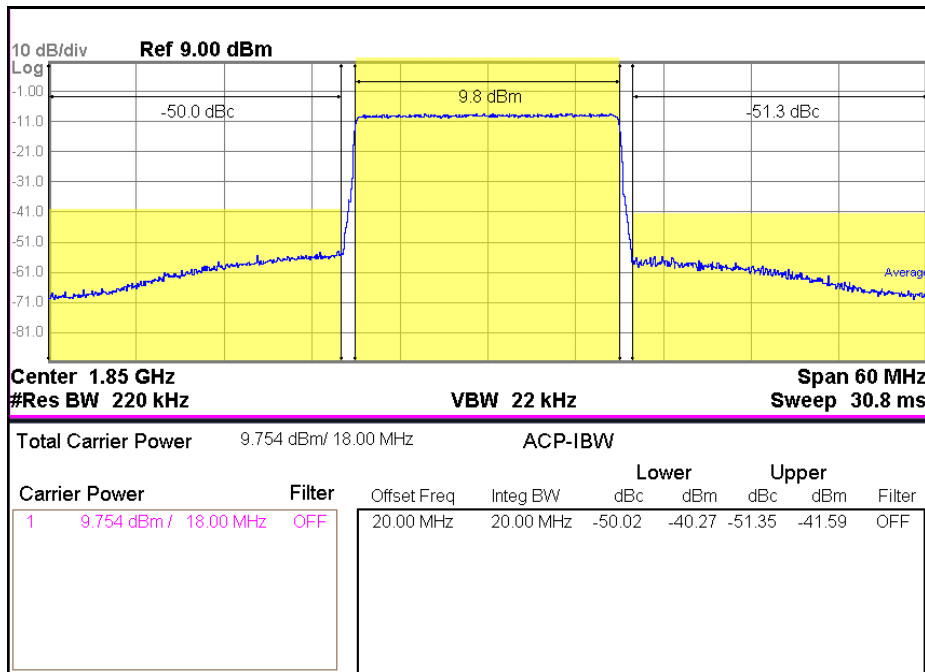

1500 -3000 MHz Wideband High Linearity LNA Gain Block

LTE TM3p1 100% 20MHz 2650MHz -50dBc (Vd=4.4V)

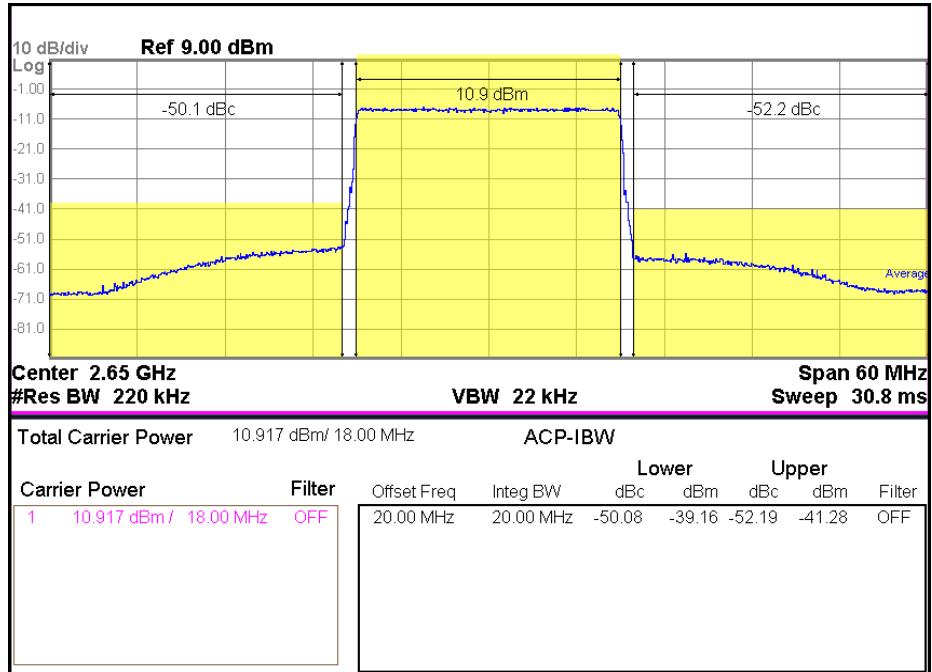

LTE TM3p1 100% 20MHz 2650MHz -50dBc (Vd=3.3V)

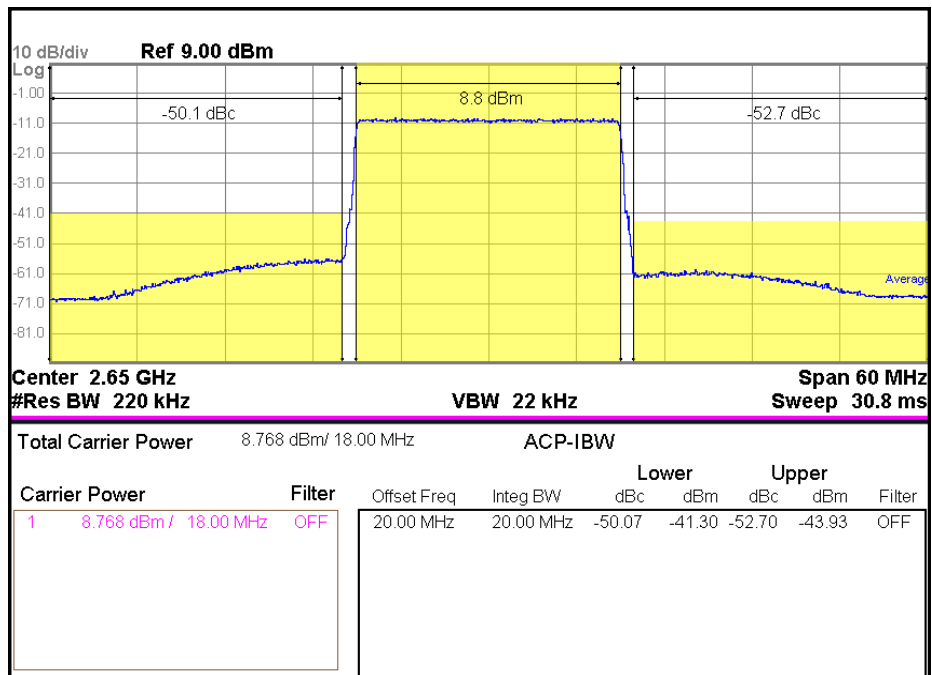

1500 -3000 MHz Wideband High Linearity LNA Gain Block

Device Performance

Pin-Pout-Gain

$V_d = 4.4V, I_d = 68mA$

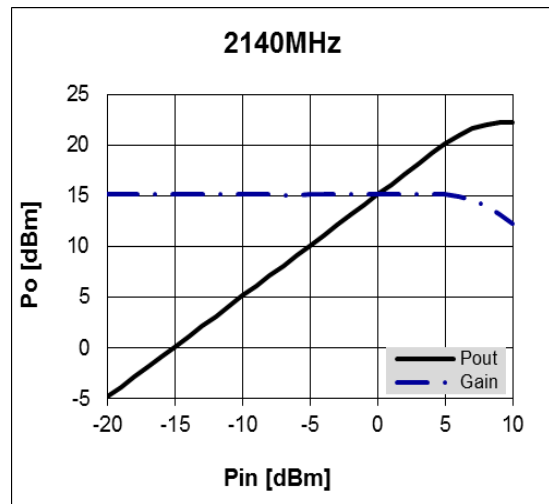
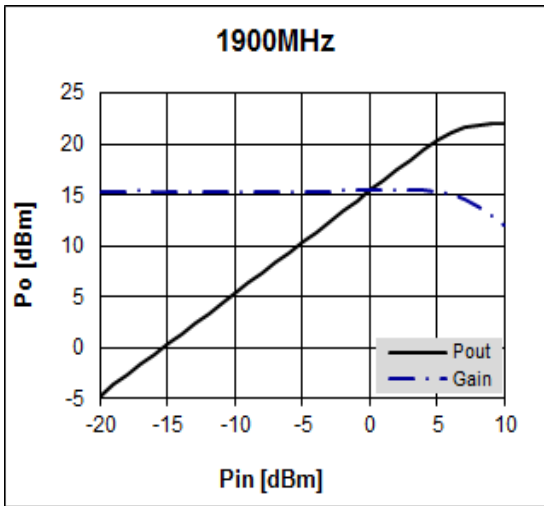

$V_d = 3.3V, I_d = 47mA$

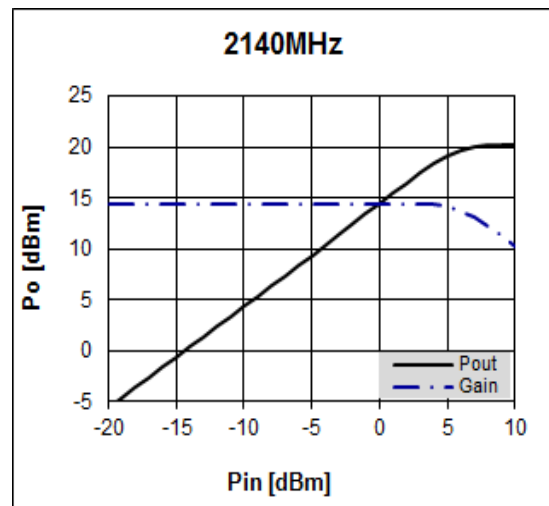
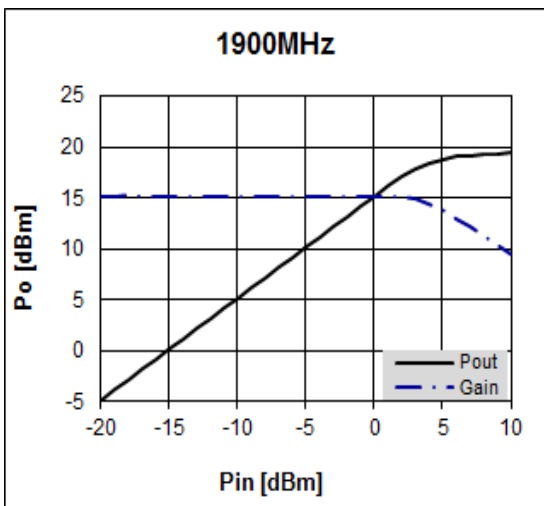

1500 -3000 MHz Wideband High Linearity LNA Gain Block

OIP3

$V_d = 4.4V, I_d = 68mA$

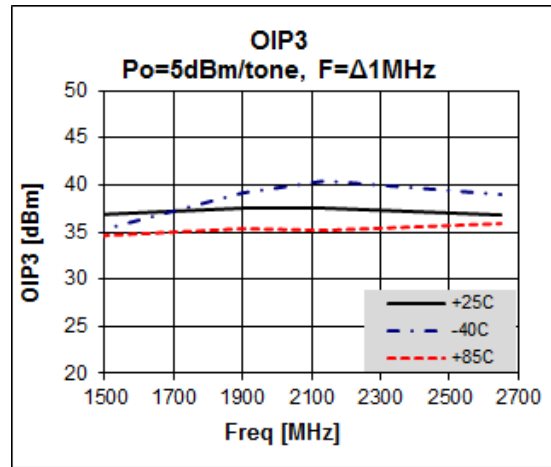
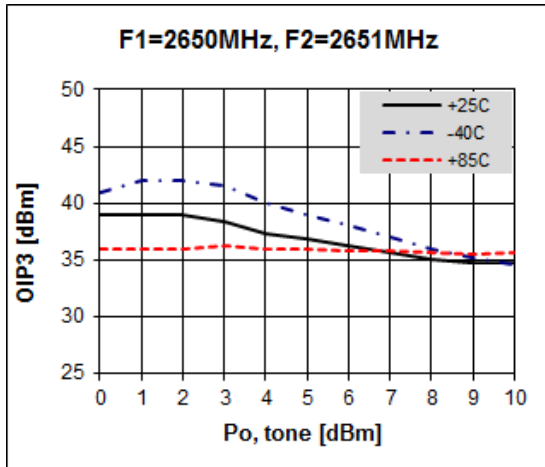
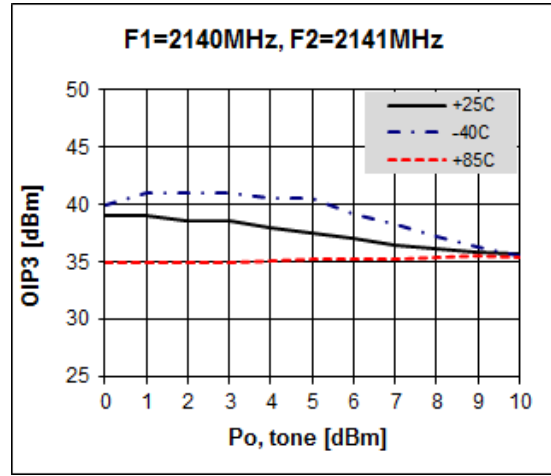
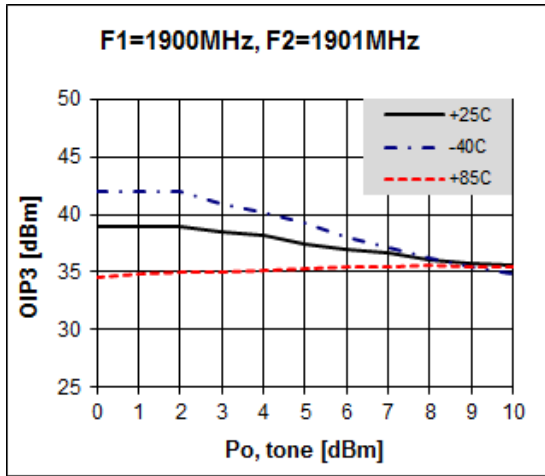

1500 -3000 MHz Wideband High Linearity LNA Gain Block

OIP3

$V_d = 3.3V, I_d = 47mA$

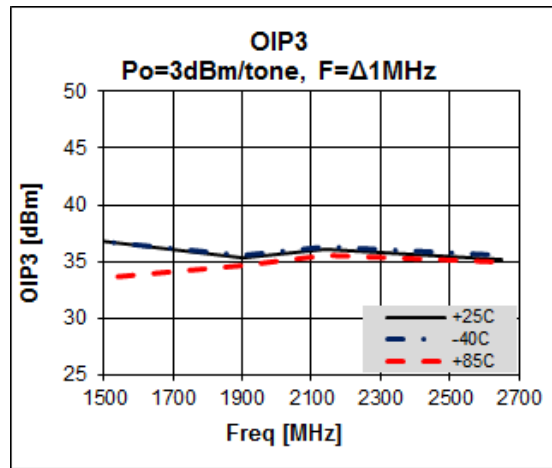
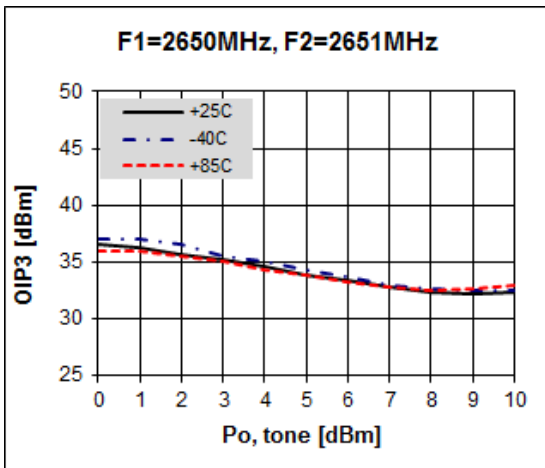
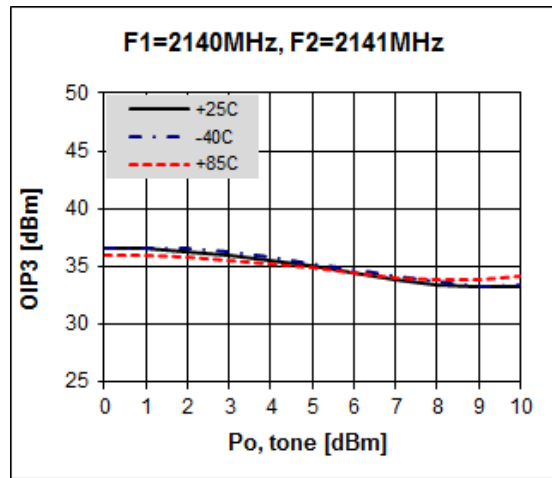
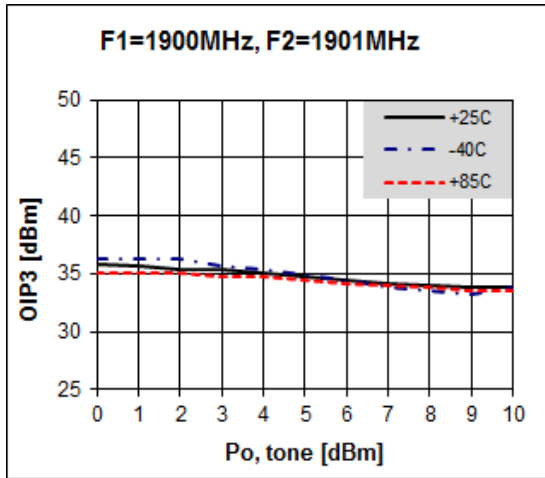

1500 -3000 MHz Wideband High Linearity LNA Gain Block

ACLR

$V_d = 4.4V, I_d = 68mA$

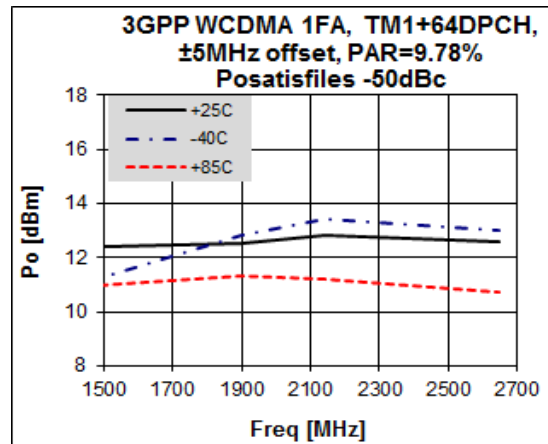
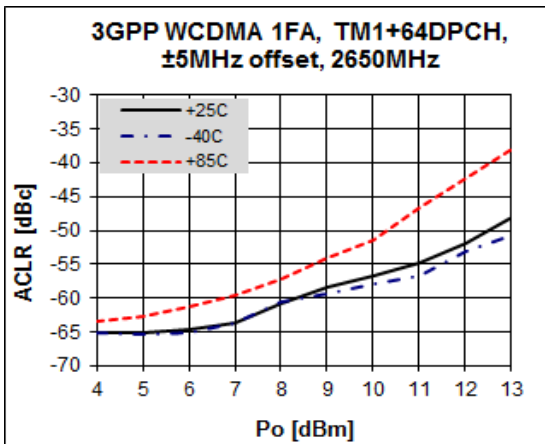
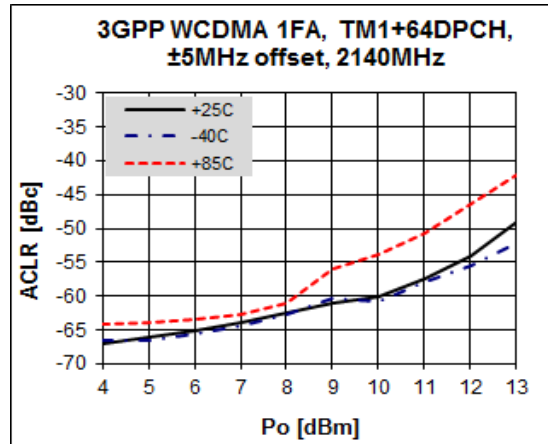
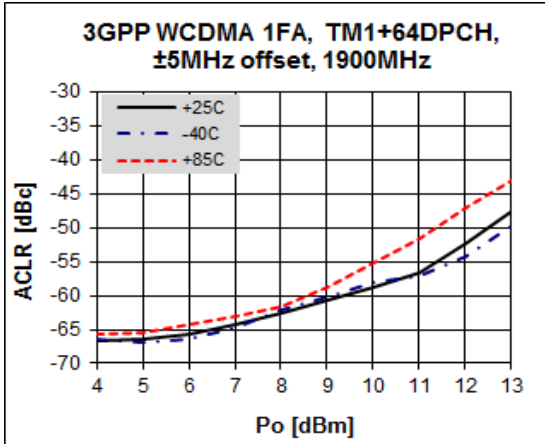

1500 -3000 MHz Wideband High Linearity LNA Gain Block

ACLR

$V_d = 3.3V, I_d = 47mA$

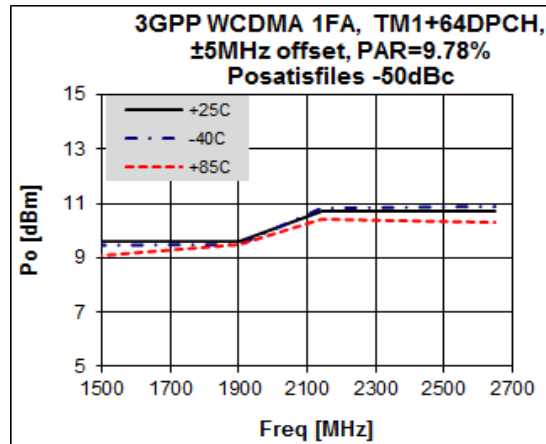
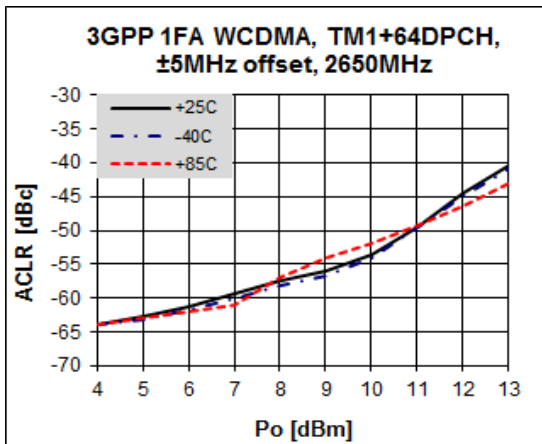
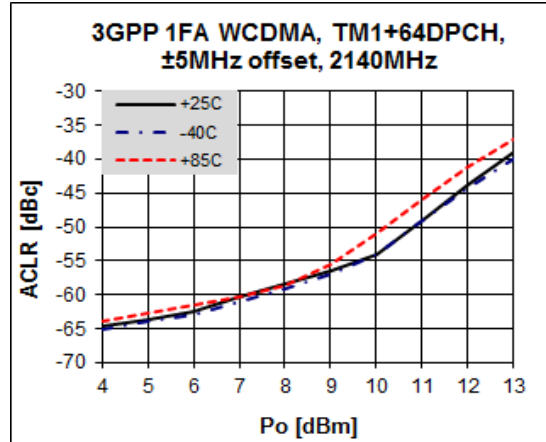
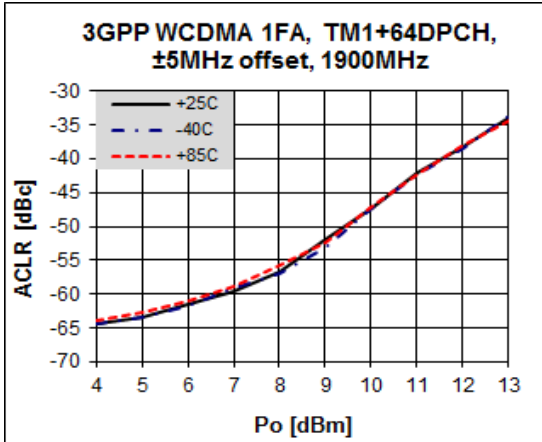

1500 -3000 MHz Wideband High Linearity LNA Gain Block

Gain Flatness

$V_d = 4.4V, I_d = 68mA$

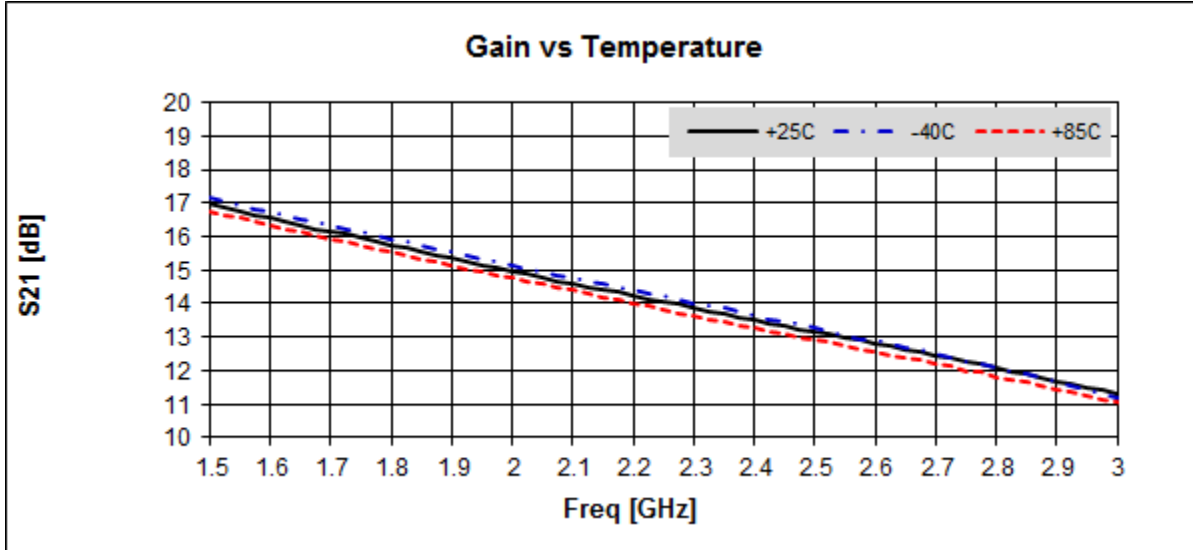

$V_d = 3.3V, I_d = 47mA$

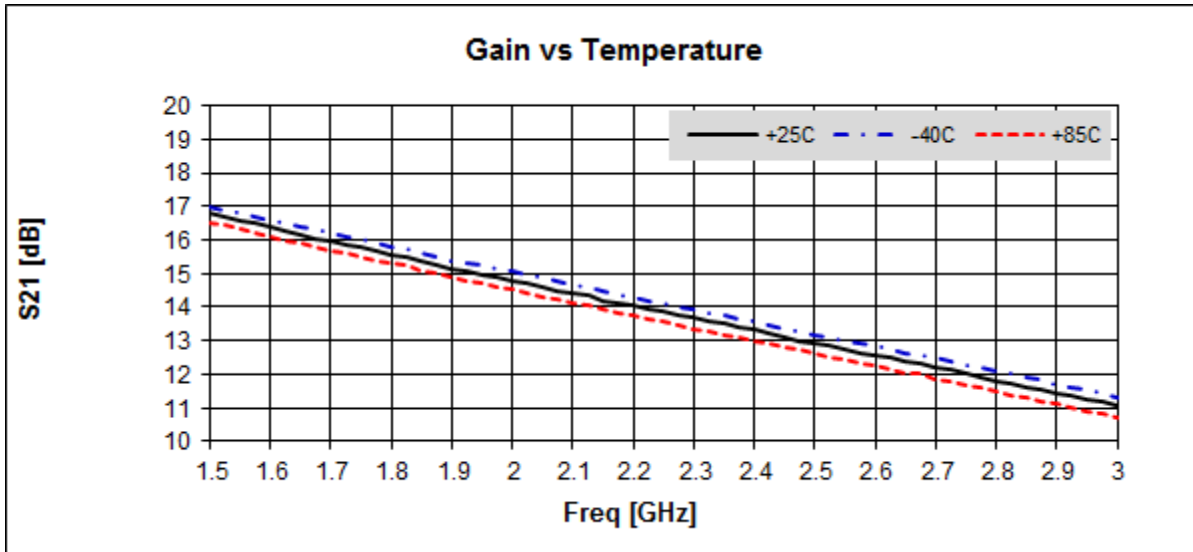

1500 -3000 MHz Wideband High Linearity LNA Gain Block

Package Outline Dimension

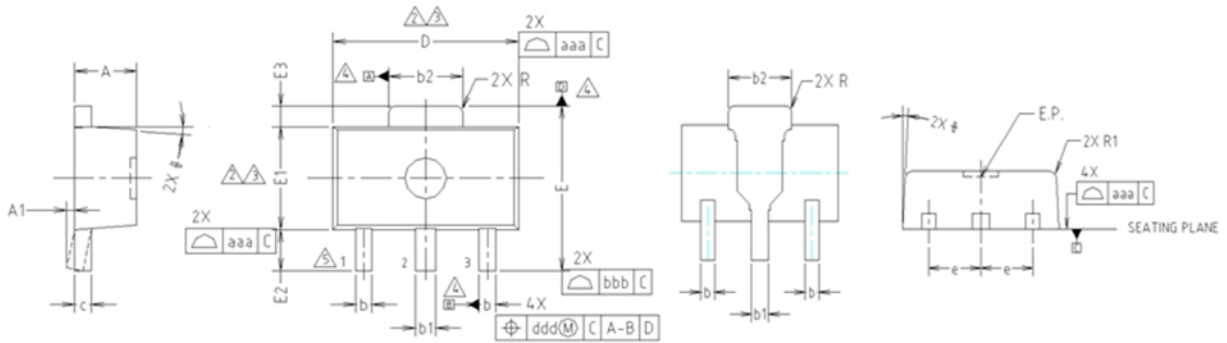

- NOTE:**
 1. DIMENSIONS IN MILLIMETERS.
- ⚠ DIMENSION D DOES NOT INCLUDE MOLD FLASH, PROTRUSIONS OR GATE BURRS. MOLD FLASH, PROTRUSIONS OR GATE BURRS SHALL NOT EXCEED 0.5mm PER END. DIMENSION E1 DOES NOT INCLUDE INTERLEAD FLASH OR PROTRUSION. INTERLEAD FLASH OR PROTRUSION SHALL NOT EXCEED 0.5mm PER SIDE.
 - ⚠ DIMENSIONS D AND E1 ARE DETERMINED AT THE OUTMOST EXTREMES OF THE PLASTIC BODY EXCLUSIVE OF MOLD FLASH, TIE BAR BURRS, GATE BURRS AND INTERLEAD FLASH, BUT INCLUDING ANY MISMATCH BETWEEN THE TOP AND BOTTOM OF THE PLASTIC BODY.
 - ⚠ DATUMS A, B AND D TO BE DETERMINED 0.18mm FROM THE LEAD TIP.
 - ⚠ TERMINAL NUMBERS ARE SHOWN FOR REFERENCE ONLY.

SYMBOL	MILLIMETERS			NOTE
	MINIMUM	NOMINAL	MAXIMUM	
A	1.40	1.50	1.60	
A1	0.00	—	0.10	
b	0.38	0.42	0.48	
b1	0.48	0.52	0.58	
b2	1.79	1.82	1.87	
c	0.40	0.42	0.46	
D	4.40	4.50	4.70	2,3
E	3.70	4.00	4.30	
E1	2.40	2.50	2.70	2,3
E2	0.80	1.00	1.20	
E3	0.40	0.50	0.60	
e	1.50 TYP.			
φ	4° TYP.			
R	0.15 TYP.			
R1	—	—	0.20	
SYMBOL	TOLERANCES OF FORM AND POSITION		NOTE	
aaa	0.15			
bbb	0.20			
ccc	0.10			
ddd	0.10			

Suggested PCB Land Pattern and PAD Layout

PCB Land Pattern

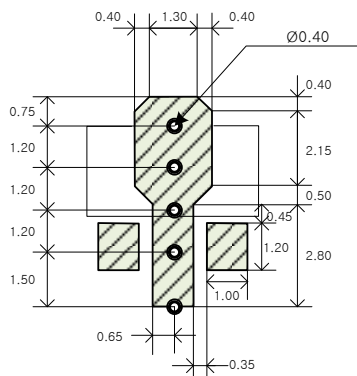

Note : All dimension _ millimeters

PCB lay out _ on BeRex website

PCB Mounting

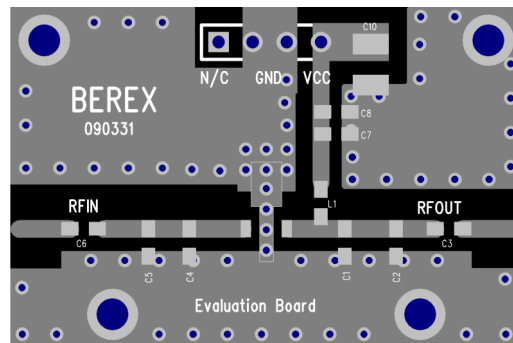

1500 -3000 MHz Wideband High Linearity LNA Gain Block

Package Marking

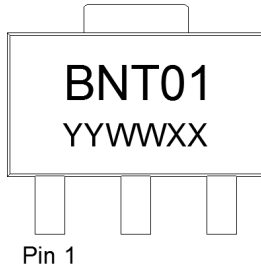

YY = Year, WW = Working Week,
XX = Wafer No.

Tape & Reel

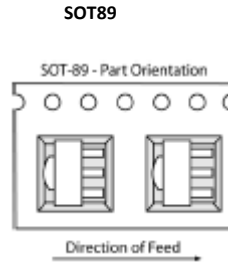

Packaging information:

Tape Width (mm): 12
Reel Size (inches): 7
Device Cavity Pitch (mm): 8
Devices Per Reel: 1000

Lead plating finish

100% Tin Matte finish

(All BeRex products undergoes a 1 hour, 150 degree C, Anneal bake to eliminate thin whisker growth concerns.)

MSL / ESD Rating

ESD Rating: Class 1A
Value: Passes <500V
Test: Human Body Model (HBM)
Standard: JEDEC Standard JS-001-2012

MSL Rating: Level 1 at +260°C convection reflow
Standard: JEDEC Standard J-STD-020



Proper ESD procedures should be followed when handling this device.

1500 -3000 MHz Wideband High Linearity LNA Gain Block

RoHS Compliance

This part is compliant with Restrictions on the Use of Certain Hazardous Substances in Electrical and Electronic Equipment (RoHS) Directive 2011/65/EU as amended by Directive 2015/863/EU.

This product also is compliant with a concentration of the Substances of Very High Concern (SVHC) candidate list which are contained in a quantity of less than 0.1%(w/w) in each components of a product and/or its packaging placed on the European Community market by the BeRex and Suppliers.

NATO CAGE code:

2	N	9	6	F
---	---	---	---	---