

RF MMIC Innovator

www.berex.com

[CLASSIFICATION] APPLICATION NOTE

[DATE] 2015.01

[REVISION No.] REV.A

[MEASURING INSTRUMENTS]

- NA_AGILENT E5071B

- SA_AGILENT E4440A

- SG_AGILENT 4438C

- SG_IFR 3416

Wide Band Gain Block Amp BG15A

Application Note



Contents

RF MMIC INNOVATOR WWW.BEREX.COM 1

1. 3500MHZ APPLICATION 3

 1.1 3500MHZ TEST RESULT(S-PARAMETER, OIP3, P1, NF,ACLR) 4

 1.2 3500MHZ LTE_20MHZ_ACLR TEST RESULT 5

2. 3700MHZ APPLICATION 6

 2.1 3700MHZ TEST RESULT(S-PARAMETER, OIP3, P1, NF,ACLR) 7

 2.2 3700MHZ LTE_20MHZ_ACLR TEST RESULT 8

1. BG15A_3500MHz Application Note

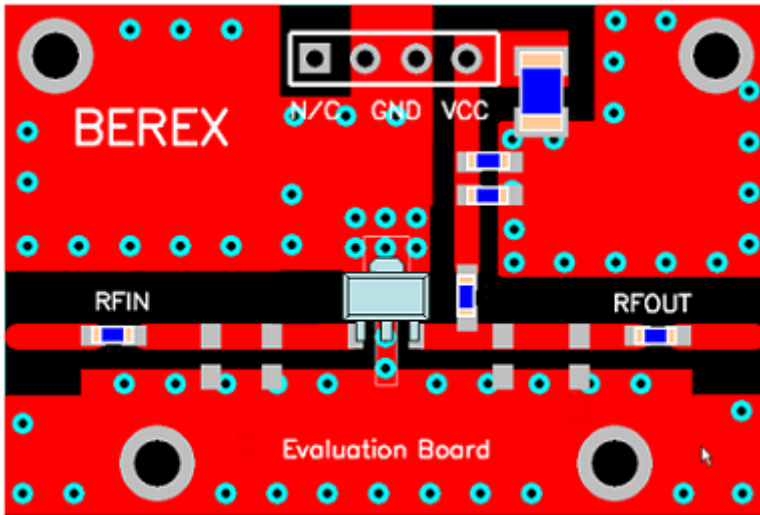

Ref. Des.	Description/ Part Number	Values	Vendor
C1	0603 CAP	100pF	Samsung
C2	0603 CAP	1nF	Samsung
C3	A3216 CAP	10uF	AVX
C4	0603 CAP	10pF	Samsung
C5	0603 CAP	10pF	Samsung
L1	0603 IND	18nH	Ceratech
U1	SOT89 PKG	BG15A	BEREX

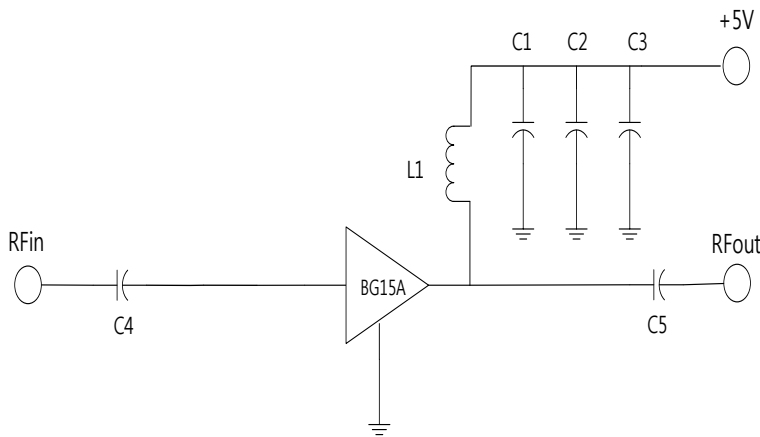

Note:

1. PCB: 31mil thick FR4

TITLE	
BG15A Evaluation Board	
(3500MHz)	
Drawing Number	Rev.
Date	Drawn By
FILE NAME	SHEET

1.1 BG15A_3500MHz Test Result

SN	Freq [MHz]	Vcc [V]	Icc [mA]	Gain [dB]	OIP3 [dBm] ⁽¹⁾	P1dB [dBm]	IRL [dB]	ORL [dB]	NF [dB]
-	3400	5	59	16.7	28.3	15.6	-15.7	-12.1	3.2
-	3500	5	59	16.7	28.2	15.6	-15.4	-12.7	3.3
-	3600	5	59	16.5	27.9	15.3	-15.2	-13.6	3.3

(1) OIP3 was tested @Pout=2dBm/tone 1MHz offset

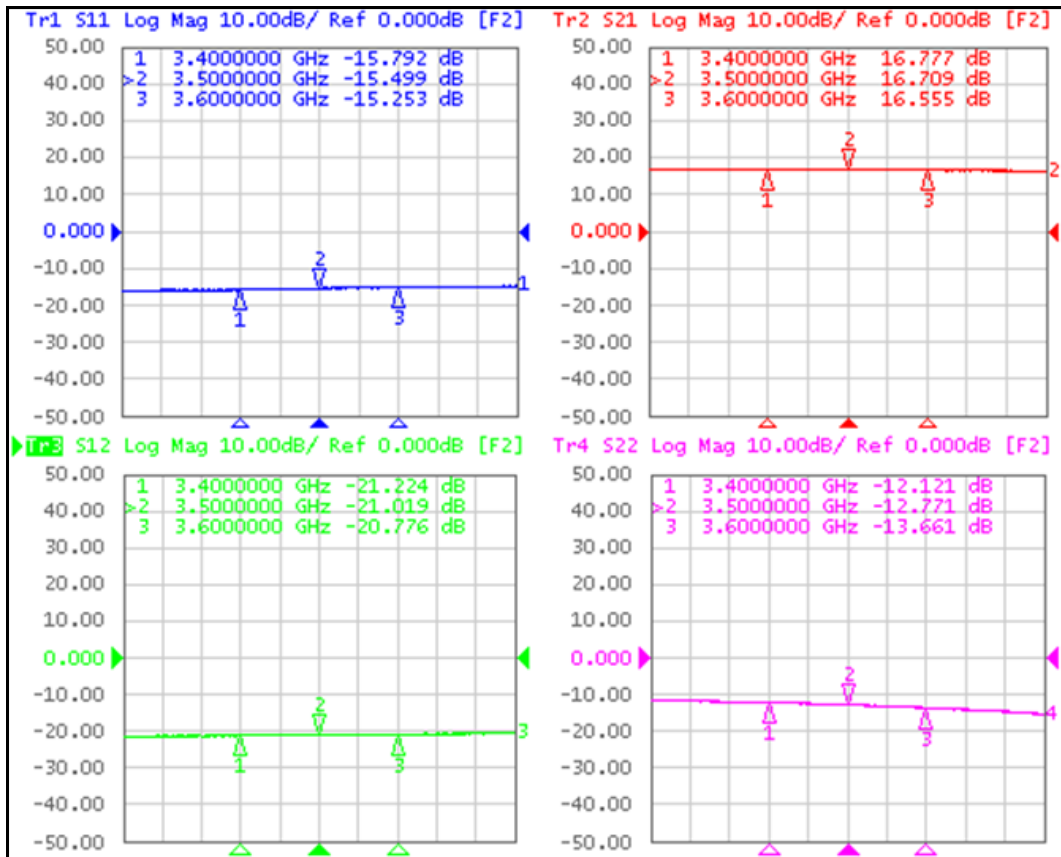

1.2 LTE_20MHz_ACLR Test Result

Out Power : 4.9 dBm

LTE_FDD_20MHz_TM 3.1_100% : 3500MHz -50dBc

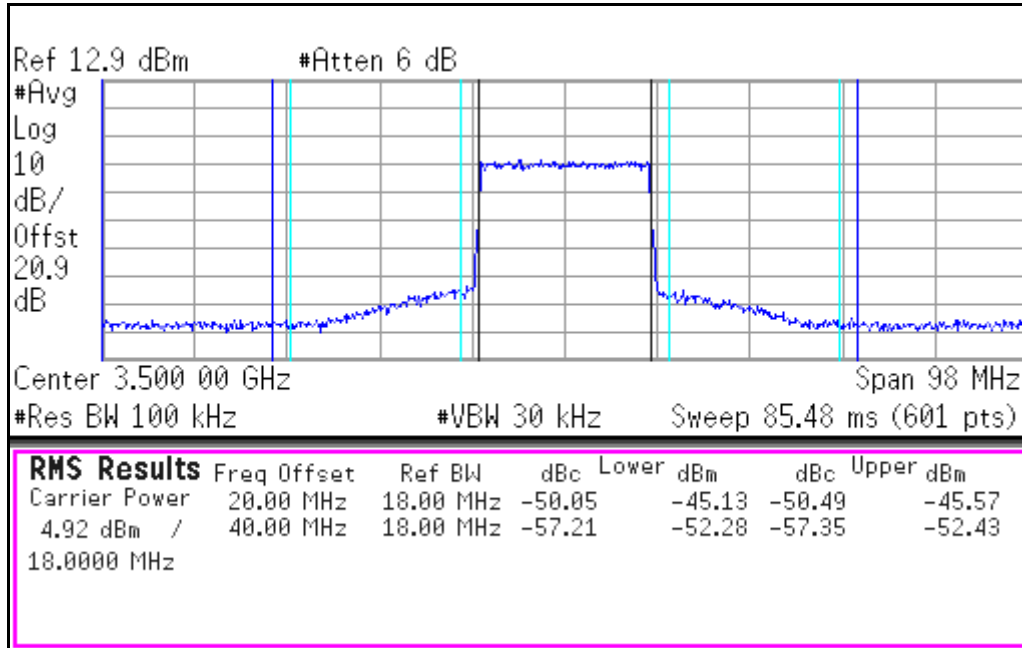

2. BG15A_ 3700MHz Application Note

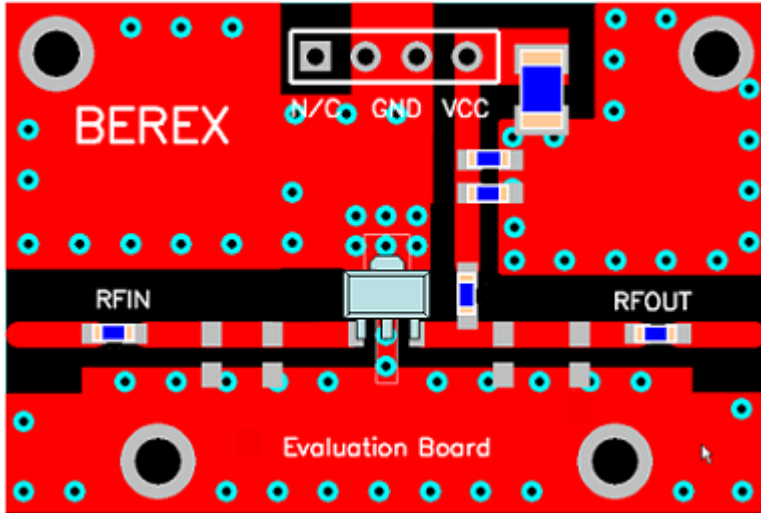

Ref. Des.	Description/ Part Number	Values	Vendor
C1	0603 CAP	100pF	Samsung
C2	0603 CAP	1nF	Samsung
C3	A3216 CAP	10uF	AVX
C4	0603 CAP	10pF	Samsung
C5	0603 CAP	10pF	Samsung
L1	0603 IND	18nH	Ceratech
U1	SOT89 PKG	BG15A	BEREX

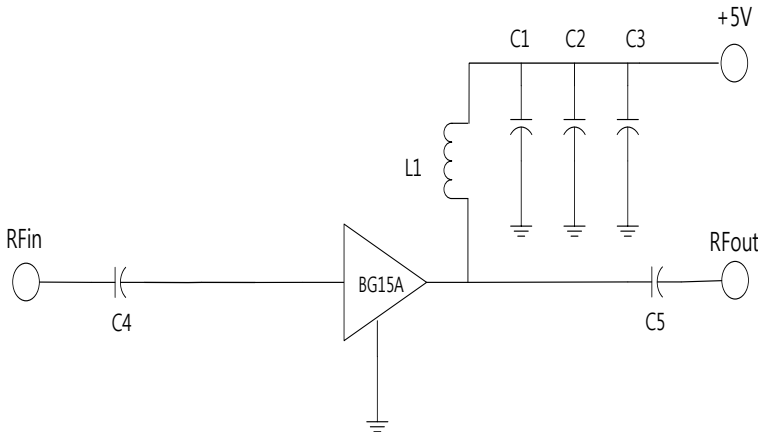

Note:

- 2. PCB: 31mil thick FR4

TITLE	
BG15A Evaluation Board	
(3700MHz)	
Drawing Number	Rev.
Date	Drawn By
FILE NAME	SHEET

2.1 BG15A_3700MHz Test Result

SN	Freq [MHz]	Vcc [V]	Icc [mA]	Gain [dB]	OIP3 [dBm] ⁽¹⁾	P1dB [dBm]	IRL [dB]	ORL [dB]	NF [dB]
-	3600	5	59	16.5	27.9	15.3	-15.1	-13.6	3.3
-	3700	5	59	16.4	27.7	15.1	-14.9	-14.7	3.3
-	3800	5	59	16.3	27.0	14.6	-14.7	-16.1	3.3

(1) OIP3 was tested @Pout=2dBm/tone 1MHz offset

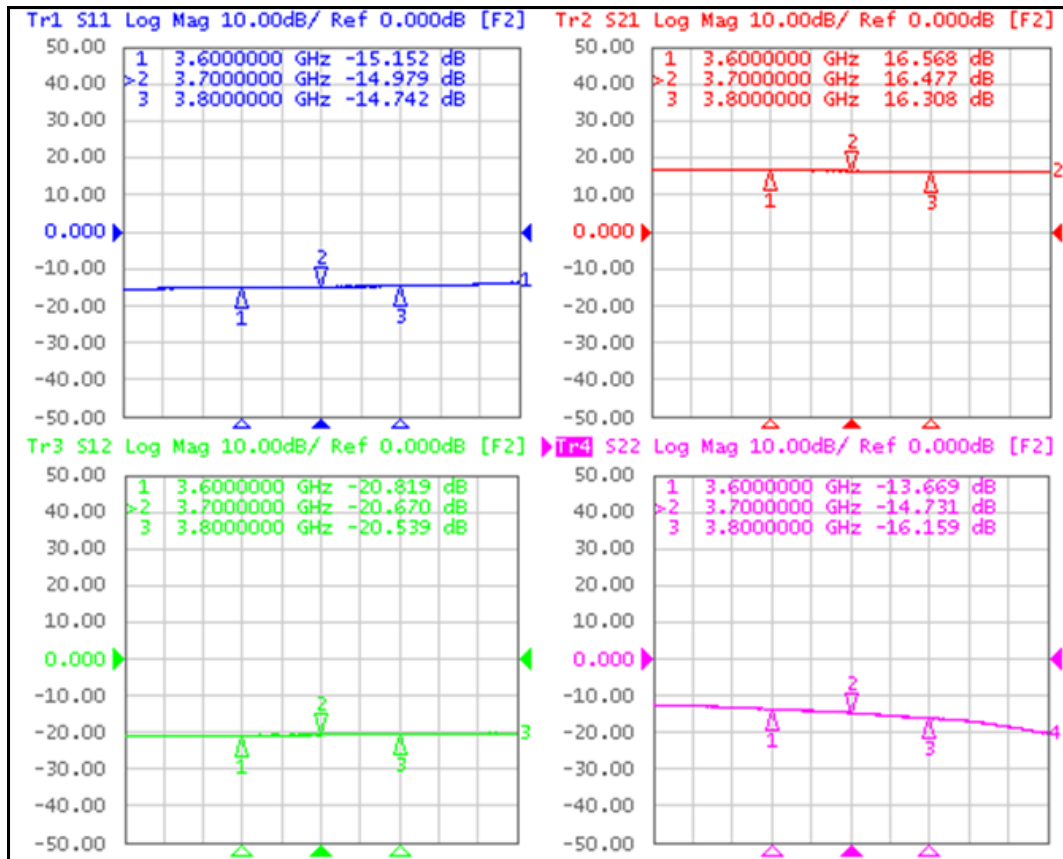

2.2 LTE_20MHz_ACLR Test Result

Out Power : 4.2 dBm

LTE_FDD_20MHz_TM 3.1_100% : 3700MHz -50dBc

